



Protocol Converter User Guide

User Guide Version 05.22

Documented Using Firmware Version 5.4.11



Figure 1.1 Protocol Converter (FDS-PC)



Figure 1.2 Dual Port Protocol Converter (FDS-PC-DP)

Copyright and Trademark Notices

© Raymond & Lae Engineering, Inc. 2011. All rights reserved. RLE® is a registered trademark and Seahawk™, Falcon™, and Raptor™ are trademarks of Raymond & Lae Engineering, Inc. The products sold by Raymond & Lae Engineering, Inc. are subject to the limited warranty, limited liability, and other terms and conditions of sale set forth at <http://rletech.com>.

Revision History

Rev. No.	Date	Rev. No.	Date
1.0	June 2010	2.4	October 2014
1.1	August 2010	2.5	March 2016
1.2	May 2011	2.6	April 2019
2.0	November 2013	05.22	May 2022
2.1	February 2014		
2.2	February 2014		
2.3	June 2014		

Manufacturer's Notes

This product is manufactured by RLE Technologies, 104 Racquette Drive, Fort Collins, CO, 80524.

If this product is used in any manner other than that specified by the manufacturer, the protection provided by the equipment may be impaired.

Product Warranty

Warranty information for RLE products can be found at www.rletech.com.

Product Registration

Product registration helps RLE Technologies inform owners of:

- Product upgrades
- Firmware enhancements
- New products and technologies
- Special offers available only to registered users

Any information provided to RLE Technologies through the registration form will be regarded as confidential. RLE will not sell or distribute any of the information to third parties.

Technical Support

Before you install a protocol converter, refer to RLE Technologies' website, www.rletech.com, to ensure you are using the most recent version of all documentation.

Personal assistance is available Monday through Friday, from 8:00 a.m. to 5:00 p.m. MST.

A request for assistance may be sent to support@rletech.com.

Otherwise, please call us directly at: **800.518.1519**.

The following information is located on the bottom of each protocol converter. Please have this information available whenever a technical support call is placed:

Product Model Number _____
Product Serial Number _____
Product Manufacture Date _____

The protocol converter is not a field-serviceable item and must be sent back to RLE Technologies for mechanical repair. Power must be disconnected (unplugged) from the protocol converter any time the unit is mechanically serviced. Physically unplug power from the unit any time you are making wiring connections to or from the protocol converter.

RLE cannot accept an item for repair without a Return Materials Authorization number, which must be provided by RLE.

Contents

1	Product Overview	11
	Introduction	11
	Product Description	11
	Rear Panel Indicators	12
	Terminal Block Designations	13
	SW1 Switch Settings	14
2	Installation	15
	Register the Protocol Converter	15
	Mount the Protocol Converter	15
	Wire the Protocol Converter	16
	Power Supply & Ground Connections	16
	RJ45 Ethernet Connection	17
	EIA-232 COM Connection	18
	Modbus EIA-485 Connections	19
3	Configuration	21
	Configure Communications	21
	Set the IP Address Using a Web Browser	22
	Set the IP Address Using an EIA-232 Connection	24
	Log In to the Protocol Converter	25
	Configure Network and Web Properties	27
	Set and Synchronize the Clock	29
	Network Time Protocol (NTP)	30
	Configure Slave Devices	31
	Configure Device Registers	33
	Enable Write Operations to Devices	33
	Register Configuration Web Pages	34
	Modbus Register Configuration	35
	SNMP Register Configuration	39
	BACnet Register Configuration	42
	Delete All Registers	45
	Set Communication Protocol Options	46
	Modbus/EIA-485 Port Configuration	46
	BACnet Server Configuration	48
	SNMP	50
	SMTP (Email)	51
4	Modbus Communications	53
	Implementation Basics	53
	Modes of Transmission	53
	Slave Address Field	54
	Function Field	54
	Data Field	54
	Error Check (Checksum) Field	54
	Exception Responses	54
	Packet Communications for the Protocol Converter	54

Function 03: Read Output Registers	54
RTU Framing	55
A Load Firmware & Configuration Files	57
Load Flash Firmware Using MIME	57
Load Flash Firmware Using TFTP	59
Save a Configuration (.cfg) File	61
Load a Configuration (.cfg) File	62
Save a Device Configuration (.xml) File	63
Load a Device Configuration (.xml) File	64
B Troubleshooting	67
C Technical Specifications	69

Figures

Figure 1.1	Protocol Converter (FDS-PC)	2
Figure 1.2	Dual Port Protocol Converter (FDS-PC-DP)	2
1	Product Overview	11
Figure 1.1	Protocol Converter Indicators	12
Figure 1.2	Locations of Terminals	13
2	Installation	15
Figure 2.1	Protocol Converter with Mounting Brackets	15
Figure 2.2	24VDC Power Supply Connection	16
Figure 2.3	Protocol Converter Ethernet Connection to a PC Using a Crossover Cable	17
Figure 2.4	Protocol Converter Ethernet Connection to a PC on a Subnet	17
Figure 2.5	EIA-232 COM Connection	18
Figure 2.6	EIA-485 Connection, 2-wire	19
Figure 2.7	EIA-485 Connection, 4-wire	19
3	Configuration	21
Figure 3.1	Protocol Converter Login Screen	22
Figure 3.2	Protocol Converter Login Screen	23
Figure 3.3	Change the IP Address Through the Web Interface	23
Figure 3.4	Protocol Converter Login Screen	25
Figure 3.5	Protocol Converter Devices (Home) Page	25
Figure 3.6	Protocol Converter Color Codes	26
Figure 3.7	Register Status Example	26
Figure 3.8	Network and Web Configuration Screen	27
Figure 3.9	Clock Configuration Page	29
Figure 3.10	Network Time Protocol (NTP) Configuration	30
Figure 3.11	Device Configuration Screen	31
Figure 3.12	Register Configuration Page	34
Figure 3.13	Modbus Register Configuration	35
Figure 3.14	Register Configuration Navigation	37
Figure 3.15	Modbus Manual Preset Single Register Link	38
Figure 3.16	Modbus Preset Single Register Webpage	38
Figure 3.17	SNMP Register Configuration	39
Figure 3.18	Register Configuration Navigation	41
Figure 3.19	SNMP Set Register Link	41
Figure 3.20	SNMP New Value Field	41
Figure 3.21	BACnet Register Configuration	42
Figure 3.22	Register Configuration Navigation	44
Figure 3.23	BACnet Write Value Link	44
Figure 3.24	BACnet Analog Value Write Field	44
Figure 3.25	System Page—Delete All Registers	45
Figure 3.26	EIA-485/Modbus/BACnet-MSTP Ports Configuration	46
Figure 3.27	BACnet Server Configuration	48

Figure 3.28	BACnet PICS Information	49
Figure 3.29	SNMP Server Configuration	50
Figure 3.30	SMTP Configuration	51
4	Modbus Communications	53
A	Load Firmware & Configuration Files	57
Figure A.1	System Page—Load Flash Firmware	58
Figure A.2	Firmware Load Messages	58
Figure A.3	Identity Link Showing Current Firmware Version	58
Figure A.4	System Page	59
Figure A.5	Bootloader Page	59
Figure A.6	System Page—Download Configuration File	61
Figure A.7	Example Download .cfg	61
Figure A.8	System Page	62
Figure A.9	Device Configuration Link in Top Bar	63
Figure A.10	Device Configuration Webpage	63
Figure A.11	Device Configuration Link	64
Figure A.12	Device Configuration Web Page	64
Figure A.13	XML Upload Dialog	64
Figure A.14	Preset/Delete Link on Device Configuration Webpage	65
Figure A.15	Preset/Delete Dialog	65
Figure A.16	Drop-Down for Preset/Delete Dialog	65
B	Troubleshooting	67
C	Technical Specifications	69

Tables

1	Product Overview	11
	Table 1.1 LED Indicator Descriptions	12
	Table 1.2 Terminal Block Designations	13
	Table 1.3 Status Indicator Descriptions	14
2	Installation	15
3	Configuration	21
	Table 3.1 Network and Web Configuration Fields	27
	Table 3.2 Clock Fields	29
	Table 3.3 NTP (Network Time Protocol) Fields	30
	Table 3.4 Device Configuration Fields	31
	Table 3.5 Modbus Register Configuration Page Options	35
	Table 3.6 SNMP Register Configuration Options	39
	Table 3.7 BACnet Register Configuration Options	42
	Table 3.8 EIA-485/Modbus/BACnet-MSTP Ports Configuration Options	46
	Table 3.9 BACnet Server Configuration Options	48
	Table 3.10 SNMP Configuration Options	50
	Table 3.11 SMTP Configuration Options	51
4	Modbus Communications	53
	Table 4.1 Exception Codes	54
	Table 4.2 Read Output Registers Packet Structure	55
	Table 4.3 Output Registers	55
	Table 4.4 Response Sample	55
A	Load Firmware & Configuration Files	57
B	Troubleshooting	67
	Table B.1 Troubleshooting the Protocol Converter	67
C	Technical Specifications	69
	Table C.1 Technical Specifications	69

PRODUCT OVERVIEW

1.1. Introduction

This manual describes how to install the Raptor™ Protocol Converter and configure it to communicate using the Modbus, BACnet, and SNMP protocols.

IMPORTANT Basic configuration to install the hardware and connect the Protocol Converter to the network is available from RLE. However, the Protocol Converter is an advanced product, and you must have in-depth knowledge of the Modbus, BACnet, and SNMP protocols to complete the configuration.

1.2. Product Description

The Protocol Converter receives one or more protocol types and outputs up to three protocol types. The Protocol Converter can receive data from slave devices using Modbus RTU, Modbus TCP/IP, BACnet/IP, or SNMP (integer data). The Protocol Converter can then be polled by a master unit via SNMP, Modbus RTU, Modbus TCP/IP, or BACnet/IP. In addition, the Dual Port Protocol Converter can be configured as a slave (**Note:** only as a slave) and polled by a master unit via BACnet MS/TP.

There are two versions of the Protocol Converter: the “standard” version, and the “dual port” version, which contains two additional EIA-485 ports for expanded connectivity and communication.

1.2.1 Rear Panel Indicators

The back of the Protocol Converter has the following indicators:

- ◆ Two indicators to show when data is being transmitted and received through the EIA-485 port (the Dual Port Protocol Converter contains three EIA-485 ports and three sets of transmit-receive indicators). When data is either being transmitted or received, the status lights will blink. If no information is being communicated, the lights are off.
- ◆ One status indicator to show when the Protocol Converter is booting up or has an alarm condition. If neither of these is occurring, the light is off.

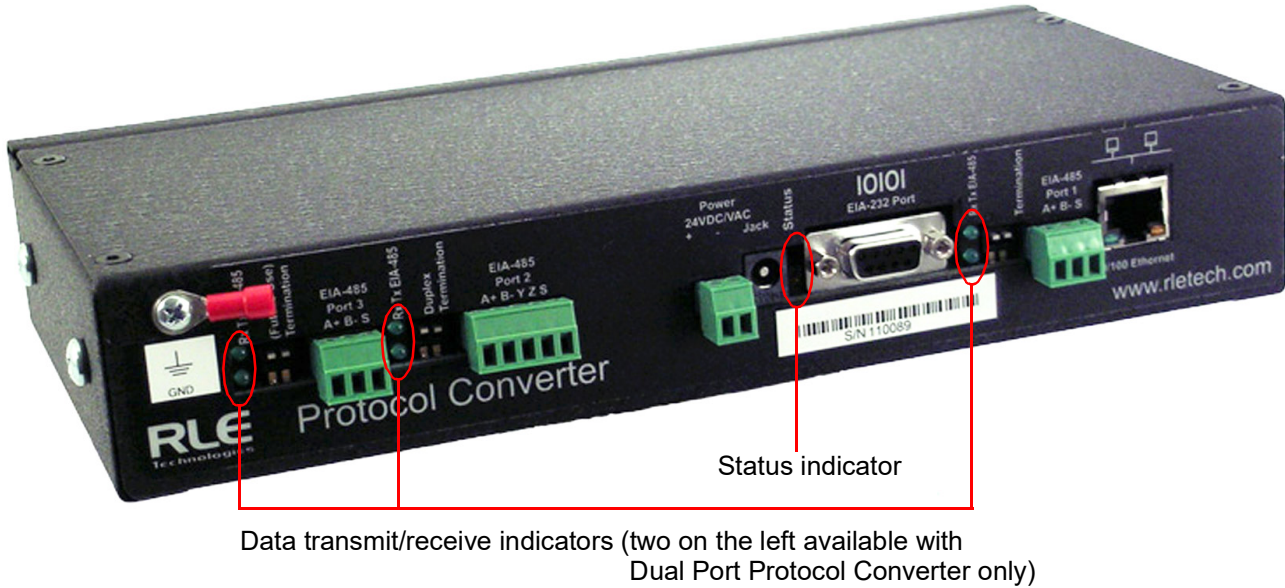
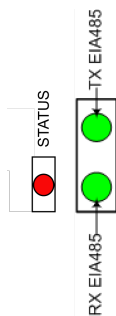

Figure 1.1 Protocol Converter Indicators



Status	Indicator
Status LED	Flashing red: Boot-up sequence
	Solid red: Alarm condition
EIA-485 TX	Flashing: Data is being transmitted.
EIA-485 RX	Flashing: Data is being received.

Table 1.1 LED Indicator Descriptions

1.2.2 Terminal Block Designations

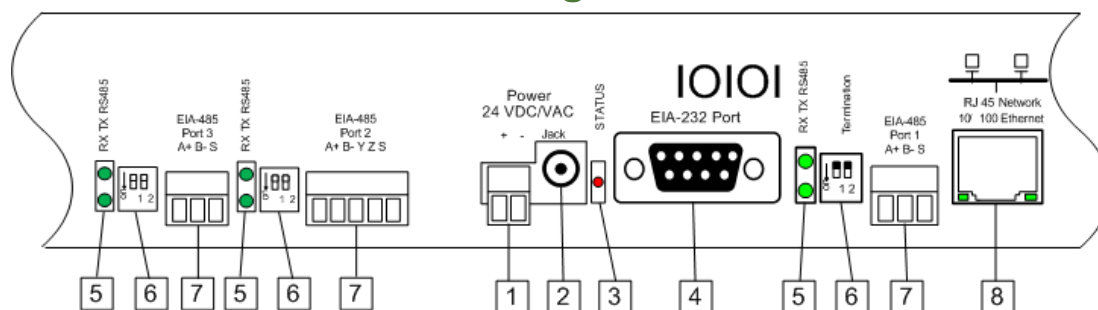
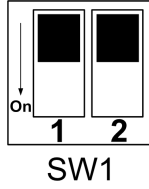

Figure 1.2 Locations of Terminals

Item No.	Item	Description
1	Power 24 VDC/VAC	Power terminal block
2	Jack	Power connector for wall wart adapter
3	Status	Status LED
4	EIA-232 Port	DB9 female connector
5	RX TX EIA-485 LED	Receive/Transmit status LED. Dual Port Protocol Converter contains two additional sets of LEDs.
6	EIA-485 Termination switch	Dual Port Protocol Converter contains two additional sets of switches; EIA-485 Port 2, the 5-pin port, can be configured as a 2-wire (half-duplex) or 4-wire (full-duplex) connection. Ports 1 and 3: Switch 1 - unused; Switch 2 - On = 100 Ohm termination Port 2: Switch 1 -Duplex (On = 4-wire; Off = 2-wire); Switch 2 - On = 100 Ohm termination
7	EIA-485 port	Dual Port Protocol Converter contains two additional EIA-485 ports. Port 2 (the middle port) can be configured as a 2-wire or 4-wire connection. In addition to all other supported protocols, Port 3 (the left most port) of the Dual Port Protocol Converter is BACnet MS/TP capable (<i>Slave only</i>).
8	RJ45 Ethernet port	10/100 BaseT connector

Table 1.2 Terminal Block Designations

1.2.3 SW1 Switch Settings



Switch	Setting
SW1-1	Dual Port Protocol Converter only: Duplex (On = 4-wire; Off = 2-wire)
SW1-2	EIA-485 Termination (On=100 Ohm termination)

Table 1.3 Status Indicator Descriptions

INSTALLATION

2.1. Register the Protocol Converter

Go to <http://www.rletech.com/> and enter the requested information in the Product Registration form. Submit the form to register your product.

2.2. Mount the Protocol Converter

The Protocol Converter comes with mounting brackets to allow the unit to be installed in a 19-inch (0.48m) rack.

- 1 Using the screws provided, attach the mounting brackets to the sides of the device.



Figure 2.1 Protocol Converter with Mounting Brackets

NOTE The brackets can be reversed so the other side of the Protocol Converter is facing outward.

- 2 Install the Protocol Converter in the rack.
- 3 Use the proper anchoring method to mount the Protocol Converter securely in the rack.

2.3. Wire the Protocol Converter

If you plan to use the EIA-485 port for Modbus RTU communication, RLE Technologies recommends an 18 AWG shielded, twisted-pair stranded copper wire for the connection. RLE recommends no more than 2,000 feet (609.6m) of wire at this specification. If longer runs are needed, contact RLE Technologies for application guidance.

2.3.1 Power Supply & Ground Connections

To provide power and ground connections to the Protocol Converter:

- 1 Connect an 18 AWG ground wire from the ground terminal to a suitable earth ground.
- 2 Connect power to the Protocol Converter in one of two ways, as shown in Figure 2.2:
 - a Plug the wall adapter (provided) into the power jack on the Protocol Converter and into a UPS outlet.
 - b Connect a dedicated 24VDC power supply to the + and - terminals to the left of the power jack.

IMPORTANT RLE Technologies recommends powering the Protocol Converter from a UPS (uninterruptible power supply) so the Protocol Converter can send alarm notifications during a power outage.

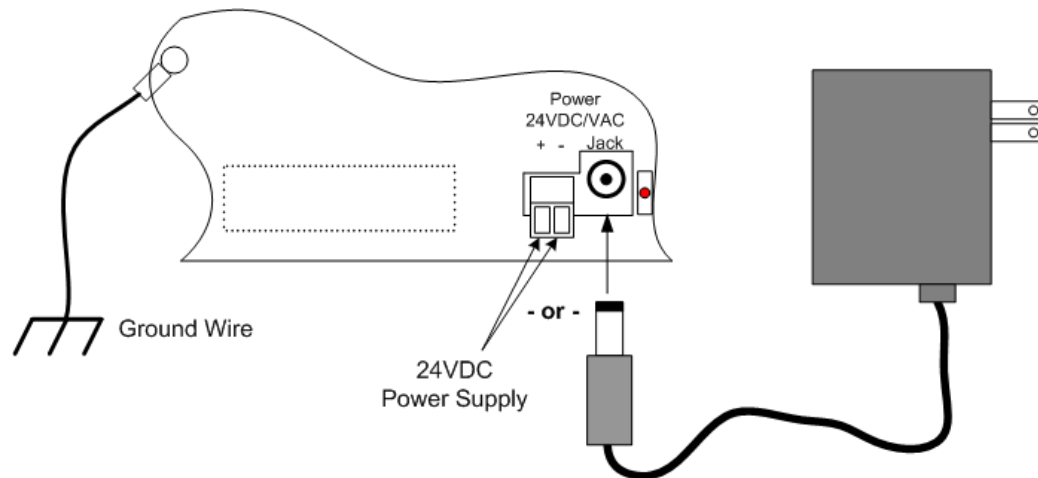

Figure 2.2 24VDC Power Supply Connection

2.3.2 RJ45 Ethernet Connection

The Protocol Converter has an internal 10/100BaseT Ethernet port used to configure the Protocol Converter. The Ethernet port supports Web browser access, BACnet, Modbus, SNMP, and SMTP (email).

Direct Connection

To make a direct connection between the Protocol Converter and a computer or laptop use a crossover network cable.

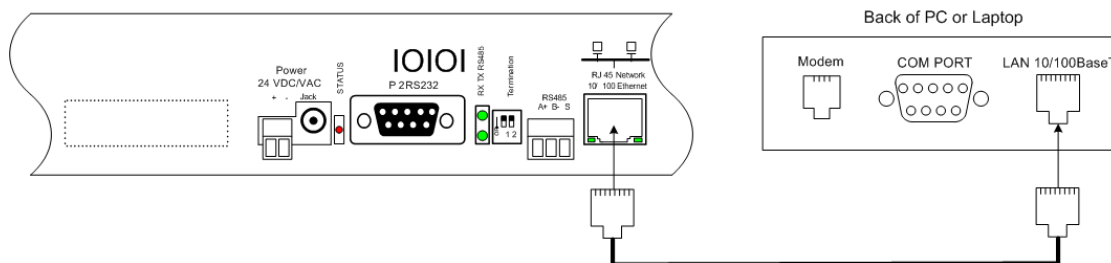

Figure 2.3 Protocol Converter Ethernet Connection to a PC Using a Crossover Cable

Subnet Connection

To connect the Protocol Converter on a subnet using a hub or switch and straight-through CAT5 cables, see [Figure 2.4](#).

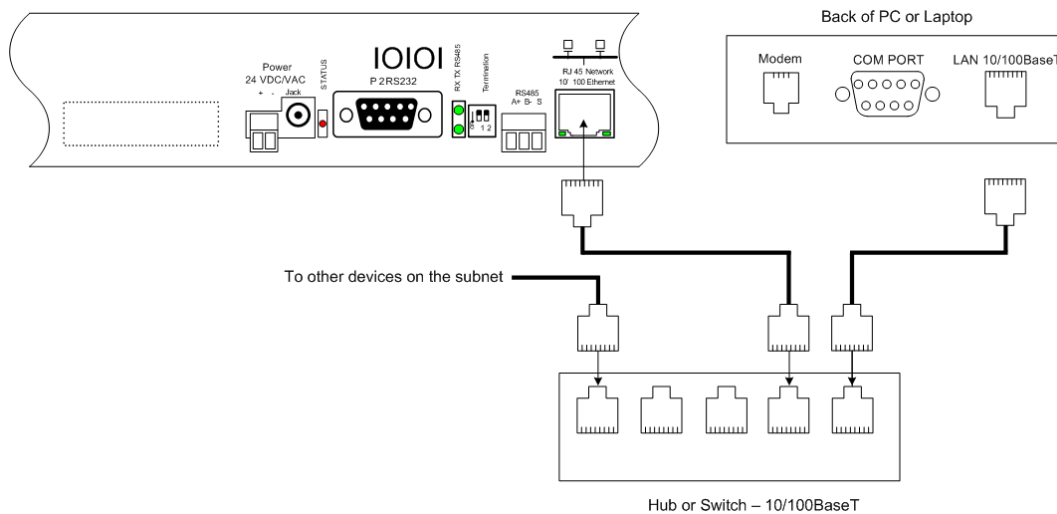

Figure 2.4 Protocol Converter Ethernet Connection to a PC on a Subnet

2.3.3 EIA-232 COM Connection

The EIA-232 port can be connected to a PC for IP configuration, firmware downloads, and troubleshooting.

NOTE The EIA-232 is typically only used as a temporary connection.

Connect the straight through, 9-pin, serial cable as shown.

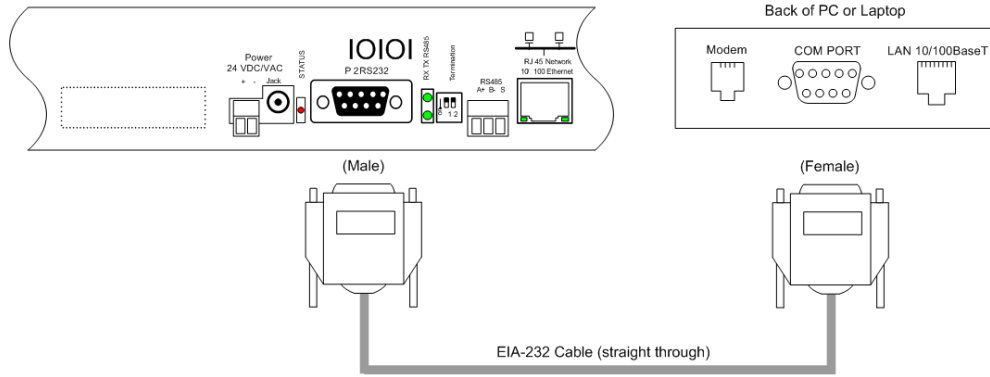

Figure 2.5 EIA-232 COM Connection

2.3.4 Modbus EIA-485 Connections

The Protocol Converter can function as a Modbus Slave or Modbus Master over an EIA-485 hardware connection. The Dual Port Protocol Converter contains three EIA-485 ports, and EIA-485 Port 2 can be configured as either a 2-wire or 4-wire connection by wiring the port appropriately and turning on the Duplex DIP switch. See [Table 1.2](#) and [Table 1.3](#) on page 14 for information about configuring this port.

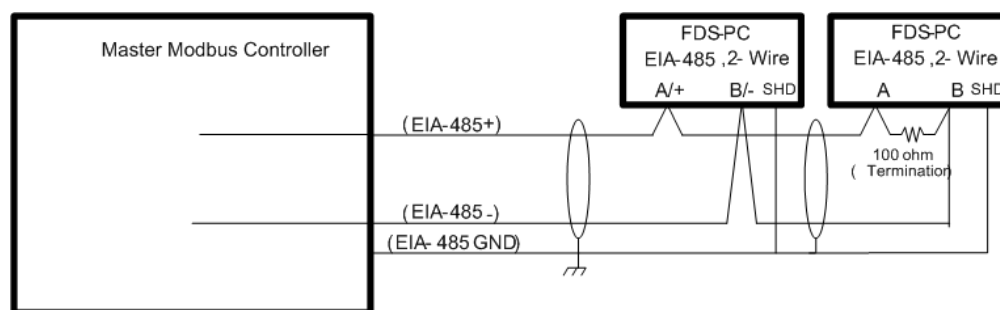
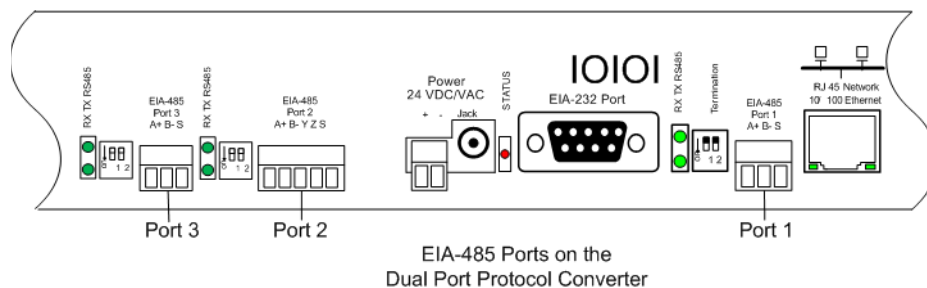

Figure 2.6 EIA-485 Connection, 2-wire

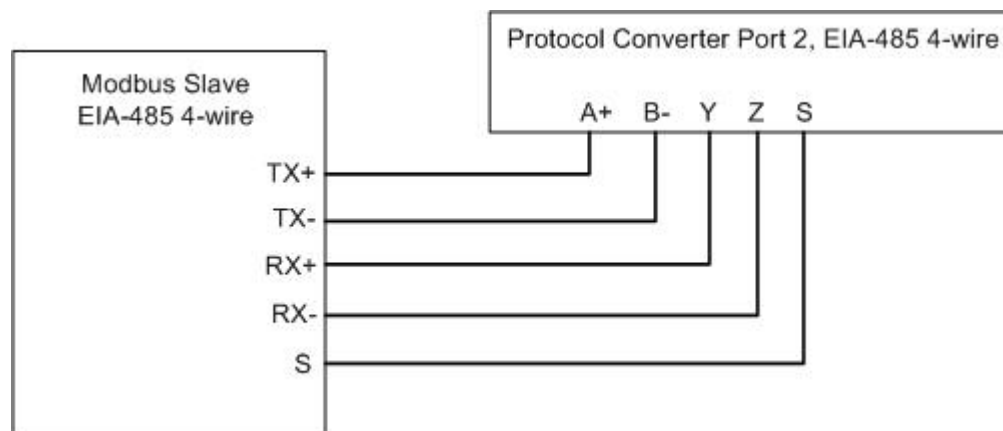

Figure 2.7 EIA-485 Connection, 4-wire

CONFIGURATION

The Protocol Converter allows you to view and configure slave devices and slave registers over the Web. To access the Web interface, you must first set up the Protocol Converter to communicate over the Internet. To set the IP address, see “[Configure Communications](#)” on page 21.

Follow the order of the sections in this chapter to completely configure the slave devices, registers, and the Protocol Converter.

3.1. Configure Communications

The Protocol Converter will not communicate over a user’s network the first time it is connected to the network. At the factory, the Protocol Converter is set with a default IP address of 10.0.0.188 and Subnet Mask: 255.255.255.0.

You must change this default address to an IP address that corresponds with your network before the Protocol Converter can communicate over the network. Use one of these vehicles to change the IP address:

- ◆ A Web browser
- ◆ The EIA-232 interface

3.1.1 Set the IP Address Using a Web Browser



WARNING

Unless you are familiar with setting the IP address, consult your IT department before attempting this procedure.

To use a Web browser to set the Protocol Converter's IP address:

- 1 Plug a crossover network cable into the laptop or workstation that will be used to configure the Protocol Converter.
- 2 Write down the computer's current IP address and Subnet Mask.

IMPORTANT You will need to change the computer's IP address and Subnet Mask back to the original settings after changing the IP address and Subnet Mask for the Protocol Converter.

- 3 Change the IP address and Subnet Mask of the computer from its existing address to one that will allow it to communicate with the Protocol Converter, such as 10.0.0.180.

NOTE It may be beneficial to set the IP address to one that is one number different from the Protocol Converter's IP address. Consult the computer's manual or your IT department before attempting this procedure.

- 4 Connect the other end of the network cable to the Ethernet port on the back of the Protocol Converter.
- 5 Access the Protocol Converter through a Web browser by typing the IP address (10.0.0.188) into the location bar.
- 6 When prompted, enter the Protocol Converter user name (fds). There is no default password; leave this field blank.

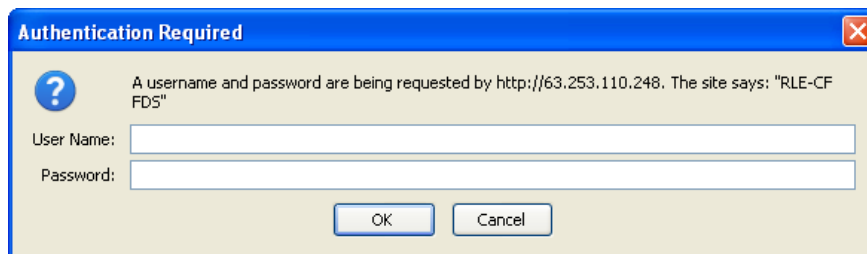

Figure 3.1 Protocol Converter Login Screen

Once you enter the correct user name, the Home page displays.

- 7 Select the **Configuration** link from the top bar, then select the Network and Web link from the Configuration menu.

The screenshot shows the Raptor RLE Protocol Converter web interface. At the top, there is a navigation bar with links for Devices, Registers, Identity, Device Configuration, Configuration, and Help. The main header displays 'Raptor' and 'RLE Technologies'. Below the header, the page title is 'RLE Protocol Converter'. A 'Configuration Menu' is visible on the left, listing various settings like Network and Web, Clock, Network Time Protocol, EIA-485/Modbus/Bacnet-Mstp Ports, Bacnet, SNMP, SMTP/DNS, System, and Product Registration. The 'Network and Web' section is highlighted in blue. A 'Submit Changes' button is located above the configuration fields. The fields include: MAC Address (00:90:5B:04:04:90), IP Address (23.24.146.51), Net Mask (255.255.255.240), Def Route (23.24.146.62), Web Password Read Only (empty), Web Password Read/Write (masked with asterisks), and Web Refresh Rate (20 Seconds). The footer shows 'FDS-PC' and '©2010 RLE Technologies'.

Figure 3.2 Protocol Converter Login Screen

- 8 On the Network and Web page, change the IP address, Subnet Mask (Net Mask), and Default Gateway (Def Route) to one provided by your network administrator.

This screenshot shows the same 'Network and Web' configuration page as Figure 3.2. The 'Submit Changes' button is visible at the top left. The configuration fields are: MAC Address (00:90:5B:00:00:C8), IP Address (10.0.0.219), Net Mask (255.255.255.0), Def Route (10.0.0.1), Web Password Read Only (empty), Web Password Read/Write (empty), and Web Refresh Rate (0 Seconds). A red circle highlights the IP Address, Net Mask, and Def Route fields, indicating they have been changed from their default values.

Figure 3.3 Change the IP Address Through the Web Interface

- 9 Press the **Submit Changes** button.

The Protocol Converter saves the new IP address, Subnet Mask, and default Gateway and then reboots.

- 10 Change the IP address of the computer back to its original IP address.

- 11 If the computer was configured as DHCP (the network domain controller assigns an IP address) return it to this state. This procedure might require assistance from your IT department, or you might need to consult the computer's manual.

The computer and the Protocol Converter are both configured to communicate on the network. Both should be accessible via the network.

- 12 Connect the computer and the Protocol Converter to the network.

- 13 From the computer's Web browser, type the new IP address of the Protocol Converter. Enter the user name and password as stated in step 8 to verify network access to the Protocol Converter.

3.1.2 Set the IP Address Using an EIA-232 Connection

To use the EIA-232 interface to set the Protocol Converter's IP address:

- 1 Connect the EIA-232 port on the Protocol Converter to a terminal or PC running terminal emulation software (HyperTerminal) with a 9-pin, male-female, straight-through serial cable.
- 2 Set the appropriate communication port to 9600 baud, no parity, 8 data bits, 1 stop bit, (9600/N/8/1), and no software or hardware flow command.
- 3 Once the terminal emulation software starts, press **Enter** on the keyboard.

The Protocol Converter's boot prompt appears, (FDS_PC>).

NOTE If the Protocol Converter's boot prompt does not appear, check the communication settings and make sure the unit is powered on.

- 4 From the boot prompt, type IP, one space, and the new IP address for the Protocol Converter, then press **Enter**.

Example:

```
IP 192.168.103.211
```

The Protocol Converter reboots after the IP address is changed.

- 5 *If you need to change the subnet mask:* From the boot prompt type NM, one space, and the new Subnet Mask address for the FDS-PC, then press Enter.

Example:

```
NM 255.255.255.0
```

The Protocol Converter reboots after the Subnet Mask is changed.

- 6 *If you need to change the default gateway:* From the boot prompt, type DG, one space, and the Default Gateway address for the Protocol Converter, then press Enter.

Example:

```
DG 192.168.103.1
```

The Protocol Converter reboots after the Default Gateway is changed.

The Protocol Converter IP address is now set, and it can be accessed through a Web browser using the new IP address. The default username is fds. There is no password; leave that field blank.

3.2. Log In to the Protocol Converter

Once the IP address for the Protocol Converter has been set as described in 3.1., “Configure Communications” on page 21, you can log in to the Protocol Converter:

Open a Web browser and type the Protocol Converter’s IP address (default is 10.0.0.188) into the location bar.

When prompted, enter the Protocol Converter user name (default is fds).

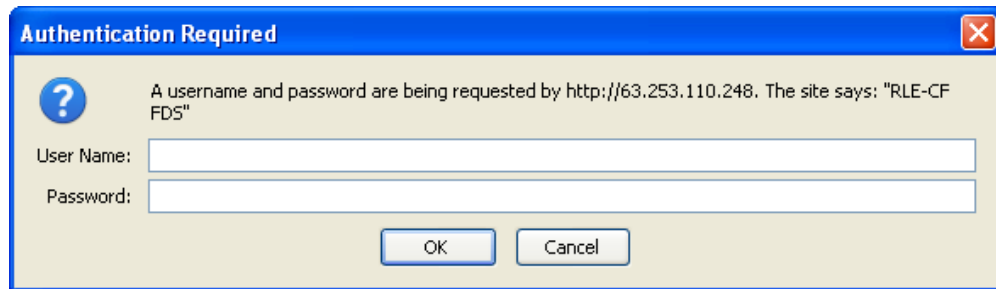

Figure 3.4 Protocol Converter Login Screen

NOTE There is no default password; if you have not set a password, leave this field blank.

Once you enter the correct user name (and password), the Devices page displays.

The Devices page of a fully configured Protocol Converter is shown below. The table on this page displays a list of configured slave devices and their status.

Raptor

Devices
Registers
Identity
Device Configuration
Configuration
Refresh
Help

Protocol Converter
THU 08/26/10 10:37:48

#	Name	Access
1	SeaHawk LD1500	Modbus/485
2	SeaHawk LD2000	Modbus/TCP
3	SeaHawk LD1500	Modbus/TCP
4	Falcon FMS-CCCC-N-24	Modbus/TCP
5	Falcon FMS-AAAA-Y-24	Modbus/TCP
6	SeaHawk LD1500	SNMP
7	SeaHawk LD2000	SNMP
8	Falcon F110	SNMP
9	Falcon F1000	SNMP
10	Falcon F3400	SNMP
11	Falcon FMS-CCCC-N-24	SNMP
12	Falcon 8126	SNMP
13	Falcon 2006	SNMP
14	Falcon FMS20U	SNMP
15	Falcon FMS20	SNMP
16	Falcon FMS32	SNMP

#	Name	Access
17	FalconLite (FLS8)	SNMP
18	Falcon FMS-X-N-24	SNMP
19	Falcon FMS-ABCM-N-24	SNMP
20	Geist R50	SNMP
21	Falcon F110	Modbus/TCP
22	Falcon F1000	Modbus/TCP
23	Falcon F3400	Modbus/TCP
24	Falcon FMS-CCCC-N-24	Modbus/TCP
25	SeaHawk LD1500	Bacnet
26	SeaHawk LD2000	Bacnet
27	Falcon 8126	Bacnet
28	Falcon 2006	Bacnet
29	Falcon FMS20U	Bacnet
30	Falcon FMS20	Bacnet
31	Falcon FMS32	Bacnet
32	FalconLite (FLS8)	Bacnet

FDS-PC
©2010 RLE Technologies

Figure 3.5 Protocol Converter Devices (Home) Page

Each device's status is color coded.

Color		Meaning
(Green)		Register is communicating properly
(Red)		Register has reached an alarm threshold
(Orange)		Register is offline - problems with the communications
(Yellow)		Register - pending alarm
(Yellow)		IP device - no arp response

Figure 3.6 Protocol Converter Color Codes

Note: The color codes are also available in the Help section of the Protocol Converter interface.

Click on an individual device number to view individual information being polled from that device to the Protocol Converter.

#	Name	Access
1	SeaHawk LD5100	Modbus/485
2	SeaHawk LD2000	Modbus/TCP
3	SeaHawk LD1500	Modbus/TCP
4	Falcon FMS-CCCC-N-24	Modbus/TCP
5	Falcon FMS-AAA-Y-24	Modbus/TCP
6	SeaHawk LD1500	Modbus/TCP

Device #1: I/O Module

#	Name	Device	Register	Value	Age
1	AC1 Current	1	40001	0	?
2	AC2 Current	1	40003	0	?
3	Hallway Temperature	1	40005	0	?
4	Room Humidity	1	40007	0	?
5	Room Temperature	1	40009	0	?
6	Underfloor Temperature	1	40011	0	?
7	AC1 Airflow	1	10001	0	?

Figure 3.7 Register Status Example

Visit the RLE website for additional documentation and troubleshooting information - click on the RLE Technologies link on the bottom right corner of the web interface.



3.3. Configure Network and Web Properties

Use the Configuration section of the Protocol Converter's web interface to configure basic device functionality. The Network and Web link displays the MAC address and allows you to fill in the IP Address, Net Mask, Default Router (Default Gateway), Passwords, and Refresh rate.

In the user interface, go to Configuration>Network and Web. Edit the fields appropriately.

The screenshot shows a web interface for configuring network and web properties. At the top, there is a blue header bar with the text "Network and Web". Below the header is a "Submit Changes" button. The configuration fields are as follows:

- MAC Address: 00:90:5B:00:00:C8
- IP Address: 10.0.0.219
- Net Mask: 255.255.255.0
- Def Route: 10.0.0.1
- Web Password Read Only: (empty text input field)
- Web Password Read/Write: (empty text input field)
- Web Refresh Rate: 0 Seconds

Figure 3.8 Network and Web Configuration Screen

Option	Description
IP Address	The Protocol Converter is configured at the factory with a default IP Address of 10.0.0.188. If you'd like to change the IP address, do so here. Default: 10.0.0.188
Net (Subnet) Mask	The Protocol Converter is configured at the factory with a default Subnet Mask of 255.255.255.0. Edit this field as necessary. Default: 255.255.255.0
Def (Default) Route	The Protocol Converter is configured at the factory with a default Gateway Route of 10.0.0.1. Edit this field as directed by your IT department. Default: 10.0.0.1
Web Password Read Only	The Protocol Converter can be configured with two passwords - the read only password allows users to access the web interface but not to edit any of the configurable settings. Specify an alphanumeric value up to 16 characters.

Table 3.1 Network and Web Configuration Fields

Option	Description
Web Password Read/Write	<p>The Protocol Converter can be configured with two passwords - the read/write password allows users to access the web interface and to edit all settings.</p> <p>Specify an alphanumeric value up to 16 characters.</p>
Web Refresh Rate	<p>This integer value represents how long the system waits until it updates the Web interface with current data. To change the rate, click in the field and type the desired amount of time (in seconds). The default refresh rate is set to 0, which means the Protocol Converter will not refresh at all. If you want the system to automatically refresh, set the refresh rate to a positive number greater than 0. The minimum recommended refresh rate is five seconds. A slower rate could cause errors that prevent the system from functioning properly.</p>

Table 3.1 Network and Web Configuration Fields (continued)

3.4. Set and Synchronize the Clock

When you're configuring the Protocol Converter, be sure to set and synchronize the Protocol Converter's clock. This ensures all time-stamped events are accurate. Do this on the Configuration>Clock screen.

Figure 3.9 Clock Configuration Page

Option	Description
Date	Enter the date in mm/dd/yy format.
Time	Enter the time in hh:mm:ss format (24-hour clock).

Table 3.2 Clock Fields

3.4.1 Network Time Protocol (NTP)

Network Time Protocol (NTP) is used to synchronize clocks of computer systems. NTP synchronizes the time of a computer or device (the Protocol Converter) to another computer or referenced time source. NTP maintains a high level of accuracy and reliability in time stamped events. NTP is found on the Configuration>Network Time Protocol screen.

NTP

Network Time (NTP) Server: (IP address or hostname)

Update Interval: (5-1440 Minutes - 0 for disabled)

Select Time Zone: ▼

Daylight Savings Time: ▼

DST Begin Date: ▼

DST End Date: ▼

Ntp server Ip Addr: 192.43.244.18

```

sysUpTime (/100): 2245
LastNtpRequestTime: 2136
LastNtpResponseTime: 2136
NextNtpRequestTime: 2436
LastTansmitTimestamp: D016A80F
Last Ntp Update: 08/18/10 12:42:23 DST (UTC -7 + 1)
    
```

Figure 3.10 Network Time Protocol (NTP) Configuration

Option	Description
Network Time (NTP) Server	The IP address or hostname of the Network Time Protocol Server with which the Protocol Converter will synchronize. Public NTP Servers include us.pool.ntp.org and time.nist.gov. Default setting: blank
Update Interval	This designates how often you'd like the Protocol Converter to access and synchronize with the NTP server. This can be set from 5 to 1440 minutes. Enter 0 to disable this feature. Default setting: 0 (disabled)
Select Time Zone	Select the time zone in which the Protocol Converter resides.
Daylight Savings Time	Select the time at which Daylight Savings Time goes into effect in your time zone. Typically, this is 2:00 A.M.
DST Begin Date	Enter the day Daylight Savings Time begins at your location.
DST End Date	Enter the day Daylight Savings Time ends at your location.

Table 3.3 NTP (Network Time Protocol) Fields

3.5. Configure Slave Devices

Once the basic functionality of the Protocol Converter has been configured, you're ready to configure slave devices. You can configure up to 32 slave devices to the Protocol Converter.

- 1 From the top navigation bar on the Protocol Converter's home page, click the Device Configuration link.

The Device Configuration page is divided into four subpages - eight slave devices can be configured on each page. These slave devices can be configured for Modbus RTU/485, Modbus TCP, SNMP V1, BACnet/IP, SNMP-RFC1628, or SNMP V2C.

Figure 3.11 Device Configuration Screen

- 2 To configure a slave device, enter the appropriate information for the communication protocol used by that device. Only the applicable fields for each communications protocol will appear. Configurable fields include:

Option	Description
Access Mode	Use the drop-down to select Modbus-RTU/485, Modbus TCP, SNMP V1, BACnet/IP, SNMP-RFC-1628, or SNMP V2. Note: RFC-1628 access mode is available for BACnet/IP only.
EIA-485 Port	Select the appropriate port.
Modbus/TCP Poll Rate	Select the number of packets per second - 10, 5, or 1.

Table 3.4 Device Configuration Fields

Option	Description
Modbus Slave Address / Unit Identifier	A numeric value that indicates the slave address for Modbus communications. Type an integer ranging from 1 to 254. If Modbus communications will not be used, leave this value at 0.
IP Address	Enter the IP address of the device being polled for Modbus TCP, SNMP, or BACnet/IP slave data.
Device Name	Enter a descriptive label to identify the slave device you are polling. This label can contain up to 30 characters.
Modbus Bulk Poll Enabled, Start Reg & Num Regs	If you're using Modbus and would like to poll multiple registers at one time, check this box. Start Reg: The number of the register where bulk polling begins. Num Reg: The number of registers that are polled in the bulk polling event.
SNMP Community	This value defines the community/string used to obtain data. This value is alphanumeric and MUST match the comm string in the slave unit - for example, public or rletech .
BACnet Device Instance, dnet & dadr	Enter the number or Device ID number assigned to the slave unit - for example 500 . This number MUST match the device ID of the slave unit. If you're using a BACnet routed device, you'll need to enter some additional information: dnet: Enter the destination BACnet network (1-65535). dadr: This is the BACnet destination address (MSTP). If you have a MS/TP routed device, enter a decimal number from 1-254. If you have an IEEE802.3 routed device, enter a MAC address in hex (for example, 00:90:5b:01:02:0c)

Table 3.4 Device Configuration Fields (continued)

- 3 Repeat this process for each slave device you want to configure.
- 4 If desired, use the Download XML link located in each device configuration box to save the device configuration and copy it to another device. Use the Upload XML link to upload the configuration to another device. See “Save a Device Configuration (.xml) File” on page 63 and “Load a Device Configuration (.xml) File” on page 64 for details.

3.6. Configure Device Registers

Once the desired slave devices have been configured on the Protocol Converter, you can program registers to those slave devices for the proper information to be polled. First, you can select whether or not to enable write operations to the slave devices, then you can program the registers.

NOTE You can also delete the Protocol Converter's entire register set. Make sure to consider this operation carefully before carrying it out.

3.6.1 Enable Write Operations to Devices

To enable the ability to write values to Modbus, SNMP, and BACnet device registers:

- 1 Click the Configuration link in the menu bar. From the Configuration menu, click the EIA-485/Modbus/BACnet-MSTP Ports link.

Configuration Menu

- Network and Web
- Clock
- Network Time Protocol
- **EIA-485/Modbus/Bacnet-Mstp Ports**
- Bacnet
- SNMP
- SMTP/DNS
- System
- Product Registration

- 2 In the top section of the EIA-485/Modbus/BACnet-MSTP Ports page, select Yes to enable the Device Write option:

Modbus/EIA-485/Bacnet-Mstp Port

Modbus/TCP/UDP Slave Unit Identifier: (1-254, 0 = disabled)

Offline Startup Delay: (minutes)

Max Eia-485 Device Response Time: (0.3-9.9 seconds)

SNMP/BacnetIP Device Poll Rate: Packets Per Second

Modbus/TCP Open Requests: (retries)

Device Write Enable: Yes No

The write operations are generated via Modbus preset single-register commands, SNMP sets, and BACnet write-property operations. Refer to the following sections on configuring Modbus, SNMP, and BACnet registers for more information about generating write operations through the Protocol Converter's user interface.

3.6.2 Register Configuration Web Pages

Access the Register Configuration page by clicking on the Registers link in the menu bar.

- 1 Click on the register number to configure individual registers.

Total Registers : 23	Page 1 of 32	Jump to page: -- ▾
----------------------	--------------	--------------------

#	Name	Device	Register	Value	Age
1	Leak Detected	1	30001	0	1
2	Cable Break	1	30001	0	1
3	Cable Contamination	1	30001	0	1
4	Leak Distance	1	30002	0	1
5	Units 1=ft, 0=Meters	1	30003	1	1
6	Leakage Current on Cable (uA)	1	30004	0	1
7	Cable Length	1	30005	698	1
8	Loop1 Resistance	1	30006	1946	1
9	Loop2 Resistance	1	30007	1950	1
10	Resistance/Ft	1	30008	2791	5
11	Leak Threshold (uA)	1	40001	150	0
12	Contamination Threshold (uA)	1	40002	50	5
13	Re-Alarm Delay (0-24 Hours)	1	40003	4	0
14	Latching Alarms (0=No 1=Yes)	1	40004	0	5
15	Silence Audible Alarm	1	40005	0	0
16	Reset Alarms	1	40006	0	5

#	Name	Device	Register	Value	Age
17	Leak Alarm Delay	1	30016	7	0
18	Contamination Delay	1	40017	120	0
19		0	---	0	?
20		0	---	0	?
21		0	---	0	?
22		0	---	0	?
23		0	---	0	?
24		0	---	0	?
25		0	---	0	?
26		0	---	0	?
27		0	---	0	?
28		0	---	0	?
29		0	---	0	?
30		0	---	0	?
31		0	---	0	?
32		0	---	0	?

Figure 3.12 Register Configuration Page

The configuration page for that register displays. Notice that the Unit number corresponds to the Device number listed on the Register Link page.

- 2 Enter the necessary information for the register type you are configuring. See Sections 3.6.3 to 3.6.5 for more information.
- 3 Click Submit.

The Protocol Converter updates the information and displays the information that applies to that unit (Modbus, SNMP, or BACnet).

3.6.3 Modbus Register Configuration

If you are configuring a Modbus device, the register configuration page looks like this:

Register #1	
Unit:	<input type="text" value="1"/> (0 - 32) (Modbus - SeaHawk LD2100) Return to Device Page
Modbus Register:	<input type="text" value="30001"/> (00000-49999 or 410000-465535)
Register Type:	Alarm Bit / ON=ALARM
Bitflag:	:0 (Read Holding/Input Registers Only)
Modbus Word Order:	<input checked="" type="radio"/> Big-Endian <input type="radio"/> Little-Endian
Gain:	<input type="text" value="1.000000"/>
Offset:	<input type="text" value="0"/>
Label:	<input type="text" value="Leak Detected"/>
Html Display:	<input checked="" type="radio"/> Integer <input type="radio"/> Float
Threshold 1:	<input type="text" value="0"/> Is Greater Than
Threshold 2:	<input type="text" value="0"/> Is Greater Than
Alarm Delay:	<input type="text" value="0"/> (Seconds)
Offline Delay:	<input type="text" value="0"/> (Seconds) (0=Disable Offline Alarms)
Current Age:	1 (Last Data Packet: 02h 00h 00h)
Local Modbus Int Register:	40001: 0
Local Modbus Float Register:	42001: 0.000000
Bacnet Instance:	bit
Bacnet Engineering Units:	<input type="text" value="0"/>
Bacnet/IP COV Client:	<input type="text" value="0.0.0.0"/> Last SubscribeCOV Time: ""
Bacnet/IP COV SPID:	<input type="text" value="0"/> <input checked="" type="radio"/> Unconfirmed <input type="radio"/> Confirmed
Bacnet/IP COV Increment:	<input type="text" value="0.000000"/>
Bacnet/IP COV Period:	<input type="text" value="0"/> (0-65535 Seconds)
Snmp registerTable Oids:	int data: 1.3.6.1.4.1.3184.1.10.3.2.1.1.2.1 float data: 1.3.6.1.4.1.3184.1.10.3.2.1.1.3.1 label: 1.3.6.1.4.1.3184.1.10.3.2.1.1.4.1 OutOfService: 1.3.6.1.4.1.3184.1.10.3.2.1.1.5.1
Snmp modbusDeviceRegisterTable Oids:	int data: 1.3.6.1.4.1.3184.1.10.3.3.1.1.2.1.30001 float data: 1.3.6.1.4.1.3184.1.10.3.3.1.1.3.1.30001 label: 1.3.6.1.4.1.3184.1.10.3.2.1.1.4.1.30001 OutOfService: 1.3.6.1.4.1.3184.1.10.3.2.1.1.5.1.30001

Figure 3.13 Modbus Register Configuration

1 Type an appropriate value in each field, or choose the value from the drop-down.

Option	Description
Unit	This is the unit number of the register you're configuring.
Modbus Register	The Modbus register to be polled by the Protocol Converter to that specific slave. The Protocol Converter can poll Coil registers (1x), Status registers (2x), Input registers (3x), and Holding registers (4x). Type a value in the range of 0000 to 49999 or 410000 to 465535.
Register Type	The register type. Choose Unsigned Integer, Signed integer, Long, Float, Alarm Bit / ON=ALARM, Alarm Bit / OFF=ALARM, Status Bit, Coil Status, Input Status, or Int64.

Table 3.5 Modbus Register Configuration Page Options

Option	Description
Bitflag	The proper bit flag to be used for this particular register. Choose values from :00 to :15.
Modbus Word Order	Determines the way the register is read by the Protocol Converter. Choose from Big-Endian (Left to Right) or Little-Endian (Right to Left).
Gain	The gain value of the raw data being received. Set this value only if necessary.
Offset	The offset value to the calculated reading for the register. Set this value only if necessary.
Label	Designate a name (label) for the register being configured. Labels can be up to 30 alphanumeric characters in length.
HTML Display	This option allows you to choose how the value is displayed on the register page. Choose from Integer (whole number) or Float (a number plus a decimal).
Threshold 1	Indicates the value that, when reached or exceeded, causes the Protocol Converter to trigger an alarm. Specify if the alarm should occur when the reading is less than (<), Equal to (=) or greater than (>) the specified threshold value.
Threshold 2	Indicates the value that, when reached or exceeded, causes the Protocol Converter to trigger an alarm. Specify if the alarm should occur when the reading is less than (<), Equal to (=) or greater than (>) the specified threshold value.
Alarm Delay	The amount of time, in seconds, that passes between the time an alarm condition occurs and the time the Protocol Converter issues an alert. The default value of 0 indicates no delay.
Offline Delay	The amount of time, in seconds, that elapses before the Protocol Converter considers the register to be stalled or offline. The default value of 0 indicates no delay.
Current Age	Indicates the amount of time, in seconds, since the Protocol Converter last received an updated value.
Local Modbus Int Register	The Modbus Integer data (whole number) used by a master device polling the Protocol Converter.
Local Modbus Float Register	The Modbus Float data (number with decimal) used by a master device polling the Protocol Converter.

Table 3.5 Modbus Register Configuration Page Options

Option	Description
BACnet Instance	The number used by a BACnet master for polling data from the Protocol Converter. Possible values include Analog Instance (AI) or Binary Instance (BI).
BACnet Engineering Units	In the BACnet ASHRAE standard, numbers correlate with units of measure. Refer to the BACnet ASHRAE standard for more information.
BACnet COV Client (COV - Change of Value)	The IP address of the BACnet master that is polling the FDS-PC.
BACnet COV SPID	Enter the Subscriber Process Identifier. You'll also need to designate if it should be Confirmed or Unconfirmed. Confirmed: When a change of value is sent to the device, it will look for an acknowledgement of the change to be sent in response. If no acknowledgement is received, the change will be sent again. This cycle will repeat until an acknowledgement is received. Unconfirmed: A change of value is sent, and the device doesn't look for an acknowledgement. Select the Confirmed or Unconfirmed radio button to indicate your preference.
BACnet COV Increment	Amount that the present value of a point needs to change before the change of value message is initiated to the BACnet master.
BACnet COV Period	Interval, in seconds, between polling operations.
SNMP register/Table OIDs	The OID (object identifier) being polled from the SNMP software. The Protocol Converter displays the OIDs used for Integer data, Float data, and the Label assigned.
SNMP Modbus Device Register/Table OIDs	Formatted to BASE.DEVICENUMBER.REGISTERNUMBER where BASE is the OID for this table, DEVICENUMBER is the device's number in the Protocol Converter (1-32) and the REGISTERNUMBER reflects the appropriate device point address.

Table 3.5 Modbus Register Configuration Page Options

- Click Submit Changes located in the upper left hand corner of the web page.
- Once the changes have been accepted, click the Next>> link in the bottom navigation bar to configure the next register.

You can also click the First, <<Prev, Last, or End links to go to those locations in the list of registers.



Figure 3.14 Register Configuration Navigation

- Write a specific value to a Modbus register by clicking the Manual Preset Single Register link on the individual register pages. This option is only available for writeable Modbus registers (40001 and above).

The screenshot shows the Raptor web interface for configuring a Modbus register. The page title is "Ricks FDS-PC" and the device is identified as "Ricks FDS-PC". The configuration page for "Register #1" includes the following fields:

- Unit: 1 (0 - 32) (Modbus - Veris BCM #1)
- Modbus Register: 40001 (00000-49999)
- Register Type: Unsigned Int
- Bitflag: 0 (Read Holding/Input Registers Only)
- Modbus Word Order: Big-Endian (selected), Little-Endian
- Gain: 1.000000

Two links are visible: "Return to Device Page" and "Manual Preset Single Register", which is circled in red.

Figure 3.15 Modbus Manual Preset Single Register Link

When you click this link, the Modbus Preset Single Register webpage displays.

The screenshot shows the "Modbus Preset Single Register 15" webpage. It includes a "Submit Changes" button and the following information:

- Device: 1 (Modbus - SeaHawk LD2100)
- Port: Ethernet
- Register: 40005
- Register type: Holding
- Label: Silence Audible Alarm
- Last Value Read: 50
- New Value:

A "Return" link is located at the bottom left of the page.

Figure 3.16 Modbus Preset Single Register Webpage

- Enter the new value for the register in the New Value box and click the Submit Changes button.

Click the Return link to go back to the register configuration page.

3.6.4 SNMP Register Configuration

If you are configuring an SNMP device, the register configuration page looks like this:

Register #1	
Unit:	<input type="text" value="2"/> (0 - 32) (Snmp - Falcon F110)
Snmp Get OID:	<input type="text"/> (object-syntax: 0)
OID Type:	<input type="button" value="Signed Int"/> ▼
Gain:	<input type="text" value="1.000000"/>
Offset:	<input type="text" value="0"/>
Label:	<input type="text" value="Leak Detected"/>
Html Display:	<input checked="" type="radio"/> Integer <input type="radio"/> Float
Threshold 1:	<input type="text" value="0"/> <input type="button" value="Is Greater Than"/> ▼
Threshold 2:	<input type="text" value="0"/> <input type="button" value="Is Greater Than"/> ▼
Alarm Delay:	<input type="text" value="0"/> (Seconds)
Offline Delay:	<input type="text" value="0"/> (Seconds) (0=Disable Offline Alarms)
Current Age:	<input type="text" value="3"/>
Local Modbus Int Register:	<input type="text" value="40001: 0"/>
Local Modbus Float Register:	<input type="text" value="42001: 0.000000"/>
Bacnet Instance:	<input type="text" value="ai:1"/>
Bacnet COV Client:	<input type="text" value="0.0.0.0"/> Last SubscribeCOV Time: ""
Bacnet COV SPID:	<input type="text" value="0"/> <input checked="" type="radio"/> Unconfirmed <input type="radio"/> Confirmed
Bacnet COV Increment:	<input type="text" value="1.000000"/>
Bacnet COV Period:	<input type="text" value="0"/> (0-65535 Seconds)
Snmp registerTable Oids:	int data: 1.3.6.1.4.1.3184.1.10.3.2.1.1.2.1 float data: 1.3.6.1.4.1.3184.1.10.3.2.1.1.3.1 label: 1.3.6.1.4.1.3184.1.10.3.2.1.1.4.1
Snmp modbusDeviceRegisterTable Oids:	

Figure 3.17 SNMP Register Configuration

1 Type an appropriate value in each field, or choose the value from the drop-down.

Option	Description
SNMP Get OID	The OID (object identifier) the Protocol Converter uses to gather the correct integer data from the SNMP device being polled.
OID Type	Select the appropriate object type: <ul style="list-style-type: none"> Signed Integer (32 bits) Float (Converted Display String)
Gain	The gain value of the raw data being received (set only if necessary).
Offset	The offset value of the calculated reading to the register.
Label	Designate a name (label) for the register being configured. Labels can contain up to 30 alphanumeric characters.
HTML Display	This option allows you to choose how the value is displayed on the register page. Choose from Integer (whole number) or Float (number plus decimal).

Table 3.6 SNMP Register Configuration Options

Option	Description
Threshold 1	<p>Indicates the value that, when reached or exceeded, causes the Protocol Converter to trigger an alarm.</p> <p>Specify if the alarm should occur when the reading is less than (<), Equal to (=) or greater than (>) the specified threshold value.</p>
Threshold 2	<p>Indicates the value that, when reached or exceeded, causes the Protocol Converter to trigger an alarm.</p> <p>Specify if the alarm should occur when the reading is less than (<), Equal to (=) or greater than (>) the specified threshold value.</p>
Alarm Delay	<p>The amount of time, in seconds, that passes between the time an alarm condition occurs and the time the Protocol Converter issues an alarm.</p> <p>The default value of 0 indicates no delay.</p>
Offline Delay	<p>The amount of time, in seconds, that elapses before the Protocol Converter considers the register to be stalled or offline.</p> <p>The default value of 0 indicates no delay.</p>
Current Age	Indicates the amount of time, in seconds, since the Protocol Converter last received an updated value.
Local Modbus Int Register	The Modbus Integer data (whole number) used by a master device polling the Protocol Converter.
Local Modbus Float Register	The Modbus Float data (number with decimal) used by a master device polling the Protocol Converter.
BACnet Instance	<p>The number used by a BACnet master for polling data from the Protocol Converter.</p> <p>Possible values include Analog Instance (AI) or Binary Instance (BI).</p>
SNMP register/Table OIDs	The OID (Object Identifier) being polled from a SNMP software. The Protocol Converter displays the OIDs used for Integer data, Float data and the Label assigned.
SNMP modbus Device Register/Table OID	Formatted to BASE.DEVICENUMBER.REGISTERNUMBER where BASE is the OID for this table, DEVICENUMBER is the device's number in the Protocol Converter (1-32) and the REGISTERNUMBER reflects the appropriate device point address.

Table 3.6 SNMP Register Configuration Options

- 2 Click Submit Changes located in the upper left hand corner of the web page.
- 3 Once the changes have been accepted, click on Next>> link at the bottom of the page.

You can also click the First, <<Prev, Last, or End links to go to those locations in the list of registers.



Figure 3.18 Register Configuration Navigation

- 4 Write a specific value to an SNMP register by clicking the SNMP Set Register link on the individual register pages.

 A screenshot of the Raptor web interface. At the top left is the 'Raptor' logo. At the top right is the 'RLE Technologies' logo. Below the logos is a navigation menu with 'Devices', 'Registers', 'Identity', 'Device Configuration', 'Configuration', and 'Help'. The main content area is titled 'Ricks FDS-PC' and has a 'Submit Changes' button. Below this is a table for 'Register #21'. The table has several rows: 'Unit' with value '5 (0 - 32) (Snmp - Liebert UPS)' and a 'Return to Device Page' link; 'Snmp Get OID' with value '1.3.6.1.2.1.33.1.9.7.0' and an '(object-syntax: integer 88)' label, with a red oval around the 'Snmp Set Register' link; 'OID Type' with a dropdown menu set to 'Signed Int'; 'Gain' with value '1.000000'; 'Offset' with value '0'; and 'Label' with value 'lowBattTime'.

Figure 3.19 SNMP Set Register Link

When you click this link, the SNMP Set Register webpage displays.

 A screenshot of the 'SNMP Set Register 21' webpage. At the top is a blue header with the title 'SNMP Set Register 21'. Below the header is a 'Submit Changes' button. The main content area displays the following information: 'Device: 5 (Snmp - Liebert UPS)', 'Port: Ethernet', 'Snmp Set OID: 1.3.6.1.2.1.33.1.9.7.0 (object-syntax: integer 88)', 'Type: Integer', and 'Label: lowBattTime'. Below this is 'Last Value Read: 88' and a 'New Value:' input field with a red oval around it. At the bottom left is a 'Return' link.

Figure 3.20 SNMP New Value Field

- 5 Enter the new value for the register in the New Value box and click the Submit Changes button.

Click the Return link to go back to the register configuration page.

3.6.5 BACnet Register Configuration

If you are configuring a BACnet device, the register configuration page looks like this:

[Submit Changes](#)

Register #1	
Unit:	3 (0 - 32) (BacnetMP - FalconLite)
Bacnet Instance:	30001 (Device Updates:0 Errors:0 Rejects:0)
Instance Type:	Analog Output
Gain:	1.000000
Offset:	0
Label:	Leak Detected
Html Display:	<input checked="" type="radio"/> Integer <input type="radio"/> Float
Threshold 1:	0 Is Greater Than
Threshold 2:	0 Is Greater Than
Alarm Delay:	0 (Seconds)
Offline Delay:	0 (Seconds) (0=Disable Offline Alarms)
Current Age:	45
Local Modbus Int Register:	40001: 0
Local Modbus Float Register:	42001: 0.000000
Bacnet Instance:	ai1
Bacnet COV Client:	0.0.0.0 Last SubscribeCOV Time: ""
Bacnet COV SPID:	0 <input checked="" type="radio"/> Unconfirmed <input type="radio"/> Confirmed
Bacnet COV Increment:	1.000000
Bacnet COV Period:	0 (0-65535 Seconds)
Snm registerTable Oids:	int_data: 1.3.6.1.4.1.3184.1.10.3.2.1.1.2.1 float_data: 1.3.6.1.4.1.3184.1.10.3.2.1.1.3.1 label: 1.3.6.1.4.1.3184.1.10.3.2.1.1.4.1
Snm modbusDeviceRegisterTable Oids:	

Figure 3.21 BACnet Register Configuration

1 Type an appropriate value in each field, or choose the value from the drop-down.

Option	Description
BACnet Instance	The Instance number used by the Protocol Converter to poll the desired data from that BACnet device.
Instance Type	Select the type of BACnet instance from the drop-down menu. Choose Analog Input (AI), Analog Output (AO), Analog Value (AV), Binary Input (BI), Binary Output (BO), Binary Value (BV), Multistate Input (MI), Multistate Output (MO), or Multistate Value (MSV).
Gain	The gain value of the raw data being received if needed. Calculate as follows: $(\text{Sensor High Range Value} - \text{Sensor Low Range Value}) / 4$
Offset	The offset value of the calculated reading to the register. Calculate as follows: $\text{Sensor Low Range Value} - \text{Gain}$
Label	Designate a name (label) for the register being configured. Labels can contain up to 30 alphanumeric characters.

Table 3.7 BACnet Register Configuration Options

Option	Description
HTML Display	This option allows you to choose how the value is displayed on the register page. Choose from Integer (whole number) or Float (a number plus a decimal).
Threshold 1	Indicates the value that, when reached or exceeded, causes the Protocol Converter to trigger an alarm. Specify if the alarm should occur when the reading is less than (<), Equal to (=) or greater than (>) the specified threshold value.
Threshold 2	Indicates the value that, when reached or exceeded, causes the Protocol Converter to trigger an alarm. Specify if the alarm should occur when the reading is less than (<), Equal to (=) or greater than (>) the specified threshold value.
Alarm Delay	The amount of time, in seconds, that passes between the time an alarm condition occurs and the time the Protocol Converter issues an alert. The default value of 0 indicates no delay.
Offline Delay	The amount of time, in seconds, that elapses before the Protocol Converter considers the register to be stalled or offline. The default value of 0 indicates no delay.
Current Age	Indicates the amount of time, in seconds, since the Protocol Converter last received an updated value.
Local Modbus Int Register	The Modbus Integer data (whole number) used by a master device polling the Protocol Converter.
Local Modbus Float Register	The Modbus Float data (number with decimal) used by a master device polling the Protocol Converter.
BACnet Instance	The number used by a BACnet master for polling data from the Protocol Converter. Possible values include Analog Instance (AI) or Binary Instance (BI).
SNMP Register/Table OID	The OID (Object Identifier) being polled from a SNMP software. The Protocol Converter displays the OIDs used for Integer data, Float data and the Label assigned.
SNMP Modbus Device Register/Table OID	Formatted to BASE.DEVICENUMBER.REGISTERNUMBER where BASE is the OID for this table, DEVICENUMBER is the device's number in the Protocol Converter (1-32) and the REGISTERNUMBER reflects the appropriate device point address.

Table 3.7 BACnet Register Configuration Options (continued)

2 Click Submit Changes located in the upper left hand corner of the web page.

- Once the changes have been accepted, click on Next>> link at the bottom of the page.

You can also click the First, <<Prev, Last, or End links to go to those locations in the list of registers.



Figure 3.22 Register Configuration Navigation

- Write a specific value to a BACnet register by clicking the Write Value link on the individual register pages.

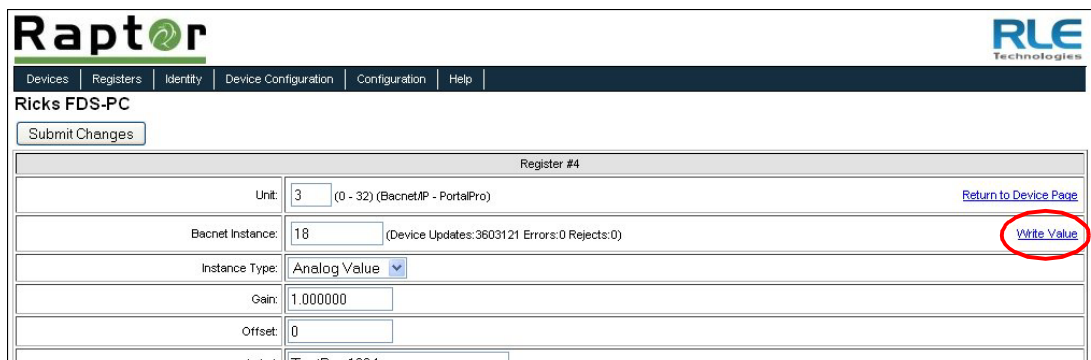

Figure 3.23 BACnet Write Value Link

When you click this link, the BACnet Analog Value Write webpage displays.

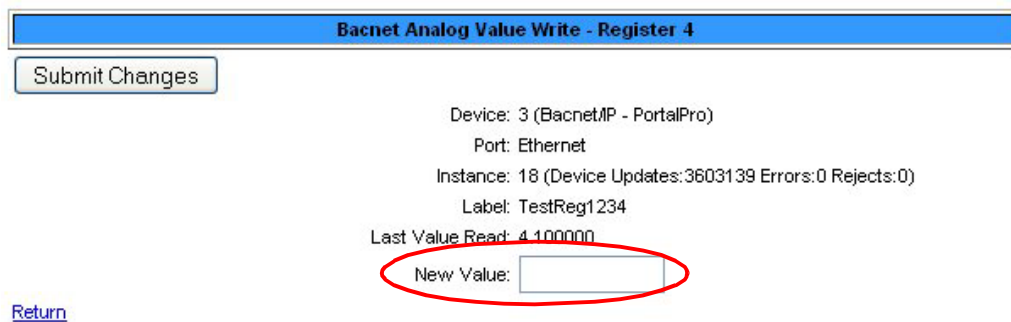

Figure 3.24 BACnet Analog Value Write Field

- Enter the new value for the register in the New Value box and click the Submit Changes button.

Click the Return link to go back to the register configuration page.

3.6.6 Delete All Registers

If you need to reconfigure the Protocol Converter for a new application, you can delete the entire register set.

IMPORTANT Consider the Delete All Registers option carefully and use it with caution. You should use this option only if you need to reconfigure the Protocol Converter for a new application.

To delete all programmed registers:

- 1 In the user interface, go to Configuration>System.

The System web page displays.

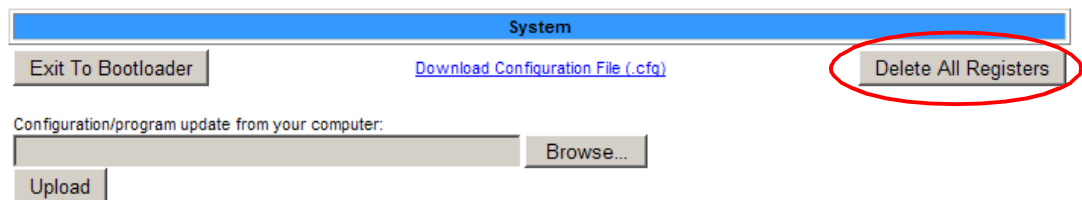

Figure 3.25 System Page—Delete All Registers

- 2 Click the Delete All Registers button.

A pop-up displays so you can confirm the delete operation.

- 3 If you are certain you want to delete all programmed registers, click OK. Otherwise, click Cancel.

When you click OK, the registers are immediately deleted.

3.7. Set Communication Protocol Options

Set the Modbus, BACnet, or SNMP protocols as described in the following sections.

3.7.1 Modbus/EIA-485 Port Configuration

To configure the Modbus/EIA-485 port, use the top navigation bar to access the Configuration screens. Select the EIA-485/Modbus/BACnet-MSTP Ports option and configure the fields accordingly.

Modbus EIA-485 Bacnet-Mstp Port

Modbus/TCP/UDP Slave Unit Identifier: (1-254, 0 = disabled)

Offline Startup Delay: (minutes)

Max Device Response Time: (0.3-9.9 seconds)

SNMP/BacnetIP Device Poll Rate: Packets Per Second

Device Write Enable: Yes No

EIA-485 Port1 Function:

EIA-485 Port1 Baud Rate:

EIA-485 Port1 Parity: None Even Odd

EIA-485 Port1 Stop Bits: 1 2

EIA-485 Port1 Slave Address: (1-254, 0 = disabled)

EIA-485 Port2 Function:

EIA-485 Port2 Baud Rate:

EIA-485 Port2 Parity: None Even Odd

EIA-485 Port2 Stop Bits: 1 2

EIA-485 Port2 Slave Address: (1-254, 0 = disabled)

EIA-485 Port3 Function:

EIA-485 Port3 Baud Rate:

EIA-485 Port3 Parity: None Even Odd

EIA-485 Port3 Stop Bits: 1 2

EIA-485 Port3 Slave Address: (1-254, 0 = disabled)

Bacnet-MS/TP Port3 Max Master:

48001 device enabled register (32bit) data: 80000007
48003 device in alarm register (32bit) data: 00000000
48005 device offline register (32bit) data: 00000000

Figure 3.26 EIA-485/Modbus/BACnet-MSTP Ports Configuration

Option	Description
Modbus/TCP/UDP Slave Unit Identifier	Designate the TCP/UDP slave address in the range 1 to 254. To disable this feature, leave the address set to 0.
Offline Startup Delay	Amount of time, in minutes, that the Protocol Converter waits before considering any slave device as offline after a power up.

Table 3.8 EIA-485/Modbus/BACnet-MSTP Ports Configuration Options

Option	Description
Max. EIA-485 Device Response Time	This setting determines the allowable response time, in seconds, from devices before the Protocol Converter times out. Set a value in the range of 0.3 to 9.9 seconds. If the Protocol Converter times out, an offline alarm will be triggered and the device's status color will change on the Protocol Converter's home page.
SNMP/BACnet/IP Device Poll Rate	Determines the rate, in packets per second, at which data is sent. The drop-down provides selections of 1, 5, or 10.
Modbus/TCP Open Requests	Define the number of retries the Protocol Converter should execute.
Device Write Enable	Determines whether or not client write operations to the Protocol Converter are translated, written to the specific server device or register and then read back by the Protocol Converter to update the local register data. The write operations are generated via SNMP Sets, BACnet Write-Property and Modbus Preset Single Register commands. Select Yes to enable the Protocol Converter to perform write operations. Default: Yes.
EIA-485 Port (1, 2, 3) Function	The port type for the EIA-485 port. Choose Modbus Slave or Modbus Master.
EIA-485 Port (1, 2, 3) Baud Rate	Speed of the EIA-485 port. Choose 1200, 2400, 9600 (default), or 19200. Ports 2 and 3 can also run at 38400 baud.
EIA-485 Port (1, 2, 3) Parity	Select None (default), Even, or Odd for the Parity output.
EIA-485 Port (1, 2, 3) Stop Bits	Select 1 or 2.
EIA-485 Slave Address	An RTU address in the range 1 to 254. To disable transmission on the EIA-485 port, leave the value at 0.
BACnet MS/TP Port 3 Max Master	Number of BACnet masters allowed on the MS/TP network.

Table 3.8 EIA-485/Modbus/BACnet-MSTP Ports Configuration Options

3.7.2 BACnet Server Configuration

From the Configuration page, click the Bacnet link to configure the BACnet Server.

Bacnet (Server)

[Bacnet Pics](#)

Device ID:

Device Name:

Description:

UDP Port: (0 = 47808)

APDU_Timeout: (seconds)

Number_of_APDU_Retries:

Bacnet COV Clients

IP Address

#1: 0.0.0.0

#2: 0.0.0.0

#3: 0.0.0.0

#4: 0.0.0.0

Bacnet BBMD-BDT

FDS IP Address: 10.0.0.219:0 Mask: 32 (FFFFFFF)

	IP Address	Port	Mask (1-32)
(Primary) #1	<input type="text" value="0.0.0.0"/>	<input type="text" value="0"/>	<input type="text" value="0"/>
#2	<input type="text" value="0.0.0.0"/>	<input type="text" value="0"/>	<input type="text" value="0"/>
#3	<input type="text" value="0.0.0.0"/>	<input type="text" value="0"/>	<input type="text" value="0"/>
#4	<input type="text" value="0.0.0.0"/>	<input type="text" value="0"/>	<input type="text" value="0"/>

Figure 3.27 BACnet Server Configuration

Enter the following settings for the BACnet server:

Option	Description
Device ID	A numeric value that uniquely identifies each BACnet Device on the network.
Device Name	Designate a name for the device, up to 40 characters in length.
Description	Ad additional descriptive information about the device as necessary, up to 40 characters in length.

Table 3.9 BACnet Server Configuration Options

Option	Description
UDP Port	<p>This is the user datagram protocol port, which is used by applications to send messages to a device (in this case, the Protocol Converter).</p> <p>Enter 0 to specify port 47808 as the UDP port. If another port is specified by your application, enter a new port number in this field.</p> <p>Default setting: 0 (47808)</p>
BACnet-MS/TP Port3 Max Master	<p>Set the slave address, 1/127. 0 = slave only.</p> <p>Default setting: 0</p>
BACnet/IP Read-Multiple	Enable or disable this feature.
BACnet PICS link	This link displays the protocol implementation conformance statement (PICS). The PICS Web page shows general BACnet capabilities of the device (for example, available LAN options). An example of a BACnet PICS page is shown in Figure 3.28 .
Engineering Units	Click this link to view a list of the units supported by the device, coupled with their numerical BACnet identifiers.
BACnet/IP COV Clients	<p>This is a list of the BACnet clients that will receive a notification when the Protocol Converter notes a change of value (COV).</p> <p>Configure these addresses on the Registers tab.</p>
BACnet BBMD-BDT	This feature is used by some BACnet masters for discovery on different subnets. Enter information as applicable to your application.

Table 3.9 BACnet Server Configuration Options (continued)

```

BACnet interoperability building blocks supported (Annex K):
Data Sharing - ReadProperty-B DS-RP-B WriteProperty-B

Bacnet Objects:
Analog Input
  AI:1 Register #1 Data      or BI:1 Register #1 Data
  ..
  AI:1024 Register #1024 Data or BI:1024 Register #1024 Data

Property Identifiers Supported:
BACnet_Present_Value      BACnet_Object_Identifier  BACnet_Object_Name      BACnet_Object_Type
BACnet_Out_Of_Service    BACnet_Units              BACnet_Status_Flags     BACnet_Event_State
BACnet_Update_Interval   BACnet_Time_Delay(write)

Bacnet Device Objects:
BACnet_Object_Identifier  BACnet_Object_Name      BACnet_Object_Type      BACnet_System_Status
BACnet_Vendor_Name       BACnet_Vendor_Id        BACnet_Model_Name       BACnet_Firmware_Revision
BACnet_App_Software_Revision BACnet_Location         BACnet_Description      BACnet_Protocol_Version
BACnet_Conformance_Class BACnet_Services_Supported BACnet_Object_Types_Supported BACnet_Object_List
BACnet_Max_APDU          BACnet_Segment_Supported BACnet_Segment_Timeout  BACnet_APDU_Timeout
BACnet_APDU_Retries     BACnet_Bindings

Data Link Layer options:
BACnet IP, (Annex J)
MS/TP slave (Clause 9), baud rate(s): 9600, 19200, 38400

Character sets supported:
ANSI X3.4

```

Figure 3.28 BACnet PICS Information

3.7.3 SNMP

The SNMP Server configuration page allows you to set the System Name (displayed on the home page), System Contact, and System Location. You can also set up communities that allow multiple SNMP systems to access the Protocol Converter.

Note: To set up communities, you must know the IP address of the SNMP Management System and the Community String. If necessary, contact your Technical Support department to obtain the IP Address and Community String.

To configure the SNMP server, go to Configuration>SNMP. The SNMP (Server) web page displays. Configure the fields as necessary.

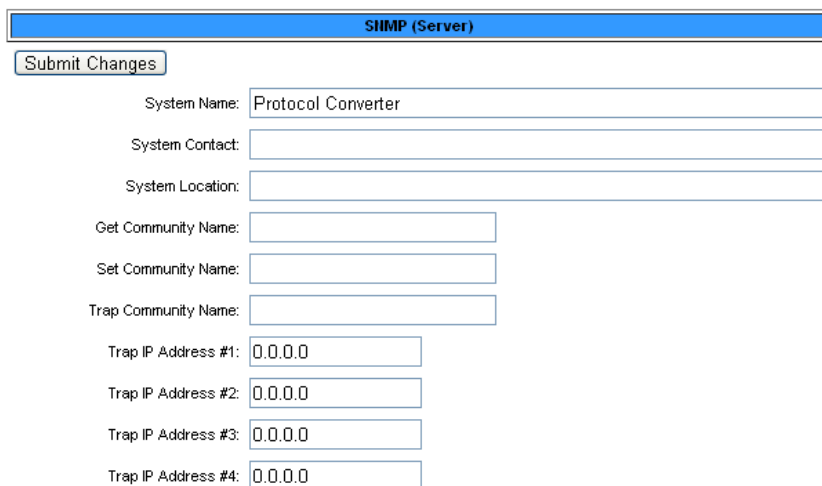

The screenshot shows the SNMP (Server) configuration page. At the top, there is a blue header bar with the text "SNMP (Server)". Below this is a "Submit Changes" button. The configuration fields are as follows:

- System Name: Protocol Converter
- System Contact: (empty)
- System Location: (empty)
- Get Community Name: (empty)
- Set Community Name: (empty)
- Trap Community Name: (empty)
- Trap IP Address #1: 0.0.0.0
- Trap IP Address #2: 0.0.0.0
- Trap IP Address #3: 0.0.0.0
- Trap IP Address #4: 0.0.0.0

Figure 3.29 SNMP Server Configuration

Option	Description
System Name	An alphanumeric name you assign to the Protocol Converter for SNMP system integration.
System Contact	The person or organization responsible for the Protocol Converter.
System Location	An alphanumeric description of the Protocol Converter's location.
Get Community Name	The name or type of password used by the SNMP server for Get communications.
Set Community Name	The name or type of password used for the SNMP server that is writing to the Protocol Converter.
Trap Community Name	The name or type of password used by the SNMP server for Trap communications.
Trap Destination IP Address	Enter up to four IP addresses to indicate where the Protocol Converter should send Trap messages.

Table 3.10 SNMP Configuration Options

3.7.4 SMTP (Email)

Use the SMTP configuration section to set up the Protocol Converter's communication to email recipients. The Protocol Converter can send email to up to four recipients. Recipients can include an exchange server using a distribution list, an email account, or a cell phone. The Protocol Converter can also communicate via ESMTP (Authenticated) to mail servers requiring a login name and password.

To access the SMTP configuration pages, go to Configuration>SMTP/DNS. The SMTP web page displays.

SMTP

Access Type: None LAN

Primary DNS Server:

Secondary DNS Server:

Mail (SMTP) Server:

Mail Sender Address:

Mail Subject:

Mail Recipient (1):

Mail Recipient (2):

Mail Recipient (3):

Mail Recipient (4):

Smt Authentication: None Plain Login

Smt Username:

Smt Password:

Mail Server DNS address logged for: "na0100.smtpout.com" 0.0.0.0

Mail Server Dns TTL: 0

Emails Pending: 2 Emails Sent: 0

Figure 3.30 SMTP Configuration

Option	Description
Access Type	Select None if email is not to be used or to temporarily disable. Select LAN to enable email notification.
Primary DNS	The first IP address used to communicate to a DNS server.
Secondary DNS	The second IP address used to communicate to a DNS server.
Mail (SMTP) Server	The IP address or host name of the mail server being used by the Protocol Converter.

Table 3.11 SMTP Configuration Options

Option	Description
Mail Sender Address	The email address used by the Protocol Converter to communicate to the mail server.
Mail Subject	Description to be displayed on the email notification subject line.
Mail Recipient (1-4)	The address for an email account, cell phone, or distribution list.
SMTP Authentication	<ul style="list-style-type: none"> • None is used for no username or password being required. • Plain is used for standard Username and password authentication. • Login is used for certain mail servers. Do not use this unless instructed by your IT department.
SMTP Username	If you choose the Login radio button for SMTP Authentication, enter the username in this field.
SMTP Password	If you choose the Login radio button for SMTP Authentication, enter the password in this field.

Table 3.11 SMTP Configuration Options

MODBUS COMMUNICATIONS

This chapter describes the Modbus communication protocol as supported by the Protocol Converter Wireless System. The content includes details and information on how to configure the Protocol Converter for communications via Modbus network.

4.1. Implementation Basics

The Protocol Converter is capable of communicating via the half-duplex EIA-485 serial communication standard. The Protocol Converter is configured to act as a slave device on a common network. The EIA-485 medium allows for multiple devices on a multi-drop network. The Protocol Converter is a slave only device and will never initiate a communications sequence.

4.1.1 Modes of Transmission

The Modbus protocol uses ASCII and RTU modes of transmission. The Protocol Converter supports only the RTU mode of transmission, with 8 data bits, no parity and one stop bit. Every Modbus packet consists of four fields:

- ◆ Slave Address Field
- ◆ Function Field
- ◆ Data Field
- ◆ Error Check Field (Checksum)

4.1.1.1 Slave Address Field

The slave address field is one byte in length and identifies the slave device involved in the transaction. A valid address range is between 1 and 254. The slave address is set on the **Modbus Device** section of the Configuration page.

4.1.1.2 Function Field

The function field is one byte in length and tells the Protocol Converter which function to perform. The supported functions are 03 (Read 4xxxx output registers).

4.1.1.3 Data Field

The data field of the request is a variable length depending on the function. The data fields for the Protocol Converter are 16-bit registers, transmitted high order byte first (big-endian).

4.1.1.4 Error Check (Checksum) Field

The checksum field lets the receiving device determine if the packet has transmission errors. The Protocol Converter RTU mode uses a 16-bit cyclic redundancy check (CRC-16).

4.1.2 Exception Responses

If a Modbus master sends an invalid command to the Protocol Converter or attempts to read an invalid register, an exception response is generated. The response packet will have the high order bit of the function code set to one. The data field of the exception response contains the exception error code.

Table 4.1 Exception Codes

Code	Name	Description
01	Illegal Function	The function code is not supported
02	Illegal Data Address	Attempt to access an invalid address
03	Illegal Data Value	Attempt to set a variable to an invalid value

4.2. Packet Communications for the Protocol Converter

This section covers the registers with the name and a brief description of each.

4.2.1 Function 03: Read Output Registers

To read the Protocol Converter parameter values, the master must send a Read Output Registers request packet.

The Read Output Registers request packet specifies a start register and the number of registers to read. The start register is numbered from zero (40001 = zero, 40002 = one, etc).

Table 4.2 Read Output Registers Packet Structure

Read Registers Request Packet	Read Registers Response Packet
Slave Address (1 byte)	Slave Address (1 byte)
03 (Function code) (1 byte)	03 (Function code) (1 byte)
Start Register (2 bytes)	Byte count (1 byte)
# of registers to read (2 bytes)	First register (2 bytes)
CRC Checksum (2 bytes)	Second register (2 bytes)
	...
	CRC Checksum (2 bytes)

Table 4.3 Output Registers

Register	Name	Description	Units	Range
40001	Integer Output	Register for Integer data	uint16	0-65535
42001	Float Output * two registers need	Register for Float data	Uint32	0-65535

4.3. RTU Framing

The example below shows a typical Query/Response from an Protocol Converter Wireless System.

Table 4.4 Response Sample

Slave Address	Function Code	Count Bytes of Data	Register Data Msb	Register Data Lsb	Register Data Msb	Register Data Lsb	Register Data Msb	Register Data Lsb	CRC 16 "Lsb"	CRC 16 "Msb"
02	04	06	00	00	00	00	00	01	B5	A3

Slave address 2 responds to Function Code 4 with six bytes of hexadecimal data and ends with CRC16 checksum.

Register Values:

40001 = 0000 (hex)

40002 = 0000 (hex)

40003 = 0001 (hex)



LOAD FIRMWARE & CONFIGURATION FILES

You can perform the following firmware and configuration operations for the Protocol Converter:

- ◆ Load different firmware to the Protocol Converter. RLE occasionally updates the firmware to add enhancement or fix errors. Firmware updates are available on the RLE website at www.rletech.com. Download appropriate firmware to an accessible place to upload to the Protocol Converter via MIME or TFTP through a LAN connection. Firmware files have a .bin extension.
- ◆ Make a backup of your custom configuration or copy the same configuration to several Protocol Converters rather than having to change the settings manually on each unit. The configuration settings are contained in a .cfg file.
- ◆ Make a copy of the configuration for a device so you can copy that configuration to other, identical devices. The configuration settings for a device are contained in an .xml file.

A.1. Load Flash Firmware Using MIME

To update the firmware for the Protocol Converter using the MIME (multipurpose Internet mail extensions) standard:

- 1 Go to the RLE website at <http://www.rletech.com>.
- 2 Locate the firmware (a .bin file) for the Protocol Converter. *Using the same filename*, save it to a local disk.

IMPORTANT Do not change the name of the firmware file when you save it. Otherwise, the Protocol Converter will not recognize the file.

- 3 In the Protocol Converter's user interface, go to Configuration>System.

The System webpage displays.

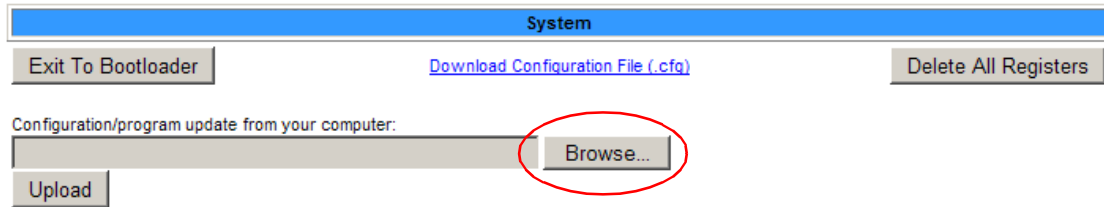

Figure A.1 System Page—Load Flash Firmware

- 4 Click the Browse button.
- 5 Locate and choose the firmware file (.bin) that you saved from the RLE website.
- 6 Click the Upload button.

While the firmware file loads, you'll see the following confirmation message:

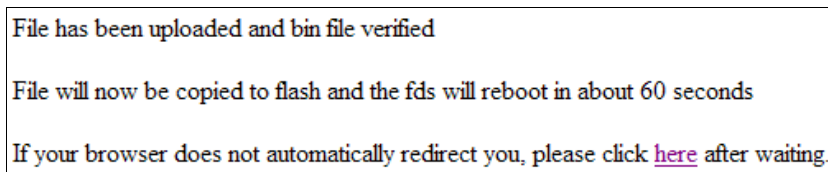

Figure A.2 Firmware Load Messages

When the file is loaded, the Protocol Converter reboots itself. The reboot process takes approximately 60 seconds. After the reboot, the Home page displays.

- 7 Click the Identity link on the top bar and verify that the new file has been loaded.

Firmware Version	FDS_PC V5.3.9
Program Size	416064
Bootloader Version	FDSBOOT V5.0.2
Option Card	Empty

Figure A.3 Identity Link Showing Current Firmware Version

A.2. Load Flash Firmware Using TFTP

Loading firmware via TFTP (trivial file transfer protocol) requires a TFTP client. It may be possible to download a free license TFTP client from the internet. Consult your IT department to determine a compatible client program.

Before updating the firmware, the firmware flash application must be exited and then erased as follows:

- 1 Verify that your PC and the Protocol Converter are on the same subnet (LAN) so the TFTP client can access the Protocol Converter.
- 2 Go to Configuration>System.

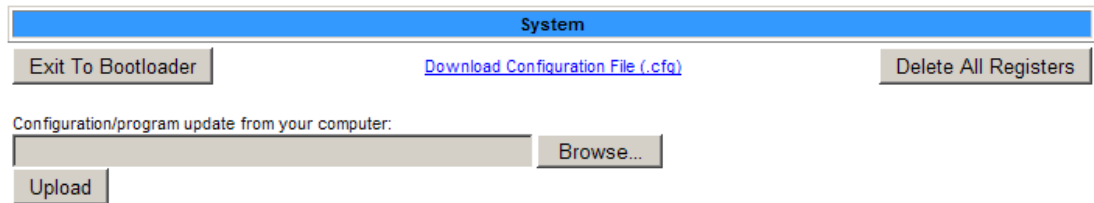

Figure A.4 System Page

- 3 Click the Exit to Bootloader button. Once exited, a bootloader web page displays at the IP address of the Protocol Converter.

RLE CF BOOTLOADER/FDS	
Firmware Version	FDSBOOT V5.0.2
MAC Address	00:90:5B:00:00:C8
IP Address	10.0.0.219
Net Mask	255.255.255.0
Def Route	10.0.0.1
TCP Max Seg Size	1436
sysUpTime	0 days 0 hrs 0 mins 15 secs
Current Time	08/19/10 11:12:22
Flash Application	FDS_PC V5.0.6
Flash Appl. Size	349440
Restart Timer	105

Figure A.5 Bootloader Page

- 4 Click the “Erase Flash” button.

Note To erase the flash, a special username and password are required. The username is **fds** (all lowercase), and the password is **rie2tech** (all lowercase). These cannot be changed.

- 5 Open your TFTP client. Configure the client as follows:

Host = Enter the Protocol Converter’s IP Address

Port = 69

Block Size = 64, 128, 256, 512, or 1024

Note The file must be sent in BINARY (not ASCII).

- 6 Send or PUT the firmware file to the Protocol Converter. It may take ~10 seconds for the firmware upload to begin. This will put the new firmware into effect.
- 7 After one minute, refresh the Protocol Converter webpage. Notice that the Flash Application field now contains the latest firmware. Click the “Start Application” button to reboot the unit.

A.3. Save a Configuration (.cfg) File

If you would like to make a backup of your custom configuration or copy the same configuration to several Protocol Converters rather than changing the settings manually on each unit, save the configuration (.cfg) file. To save the .cfg file:

- 1 In the user interface, go to Configuration>System. Click the Download Configuration File .cfg link.

The System webpage displays.

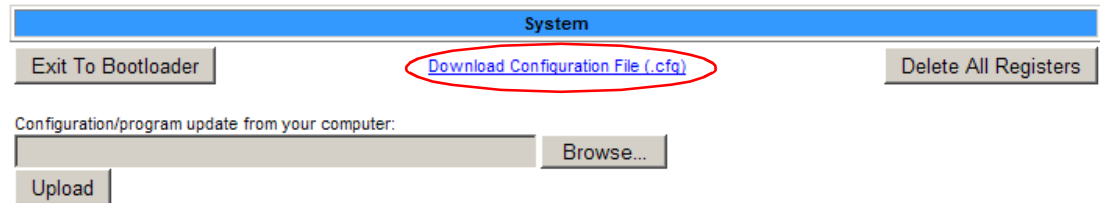

Figure A.6 System Page—Download Configuration File

- 2 A download window opens so you can save the current system configuration.

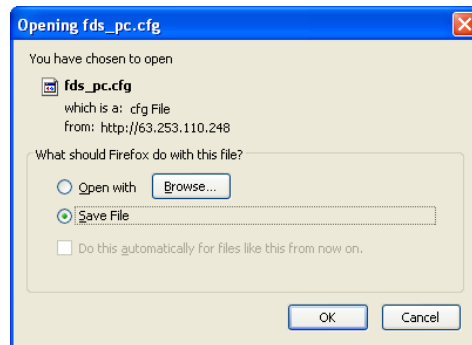

Figure A.7 Example Download .cfg

- 3 Select the Save File radio button and then click the OK button. Select the location and name for the file (**do not change the .cfg extension**). Click the Save button.

The file is saved to the location and with the name you specified.

A.4. Load a Configuration (.cfg) File

Once you have saved a configuration file as described in A.3., “Save a Configuration (.cfg) File” on page 61, you can load that file to the same Protocol Converter or other Protocol Converters.

To load a configuration file (.cfg) to the Protocol Converter:

- 1 Ensure that the .cfg file you want to load is on a local drive.
- 2 On the Protocol Converter interface, go to Configuration>System.

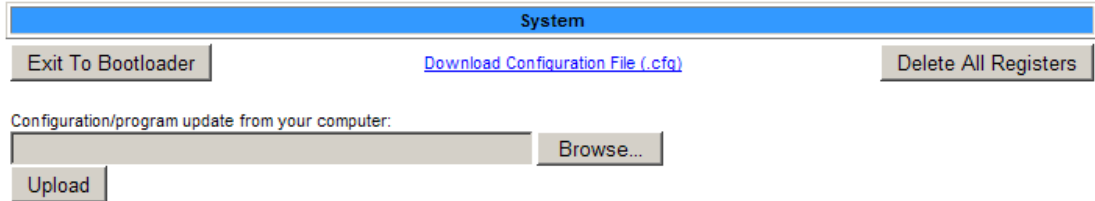

Figure A.8 System Page

- 3 Click the Browse button.
- 4 Locate and choose the configuration file (.cfg) that you saved.

The path and name of the configuration file (.cfg) displays in the field to the left of the Browse button.

- 5 Click the Upload button.

The configuration file is loaded while the Protocol Converter displays a message confirming that it is loading the new file. When the file is loaded, the Protocol Converter reboots itself. The reboot process takes approximately 60 seconds. After the reboot, the Home page displays.

A.5. Save a Device Configuration (.xml) File

When you have configured a specific device using the Protocol Converter's interface, you can save that device configuration and load it to another device of the same type. This procedure may not work in all cases; some manufacturers use the same register set across different models of the same type of device, and others do not.

To save a device configuration:

- 1 Click the Device Configuration link in the top bar.



Figure A.9 Device Configuration Link in Top Bar

- 2 The Device Configuration web page displays. Locate the configuration box for the device whose configuration you want to save.

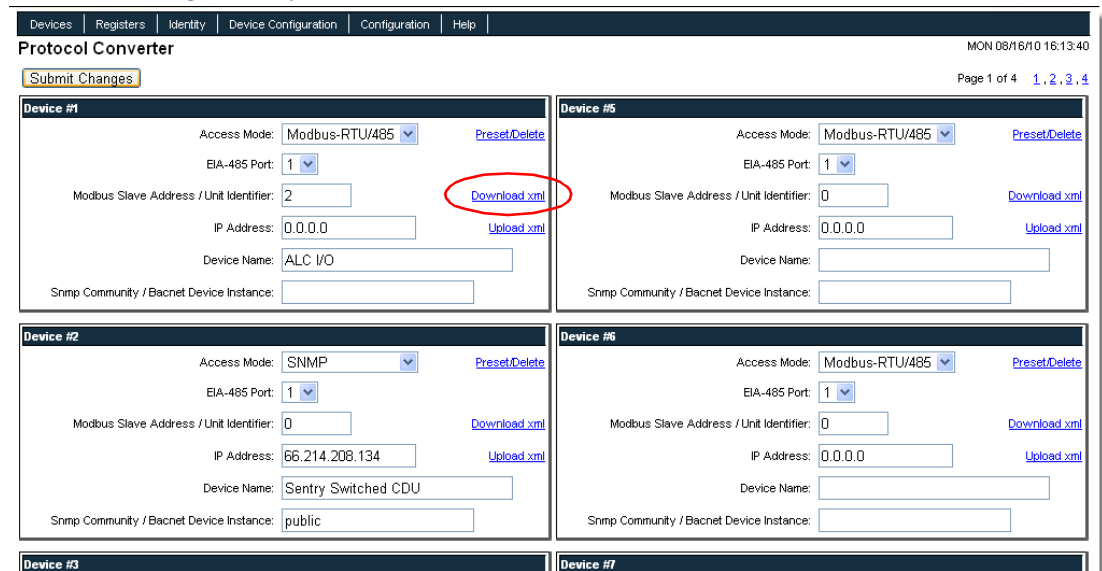

Figure A.10 Device Configuration Webpage

- 3 Click the Download XML link in that device's configuration box. Depending on your browser, take one of the following courses of action:
 - ◆ The contents of the file are opened in a browser window. You must copy and paste the contents into a text editor (such as Notepad), then save the file with an .xml extension.
 - ◆ A dialog box opens to display the file name that is automatically assigned to the device. You can choose to open or save the file. Save the file.

When you have saved the .xml file, it can be uploaded to other devices of the same type. See "Load a Device Configuration (.xml) File" on page 64 for instructions.

A.6. Load a Device Configuration (.xml) File

An .xml file that you have saved using the Protocol Converter’s user interface can be loaded to another device. This procedure may not work in all cases; some manufacturers use the same register set across different models of the same type of device, and others do not.

To load an .xml file to a device:

- 1 Click the Device Configuration link in the top bar.

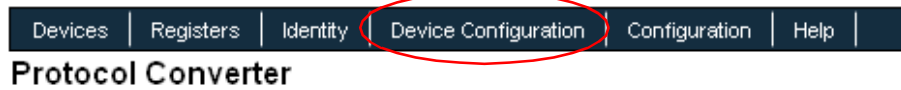

Figure A.11 Device Configuration Link

- 2 The Device Configuration web page displays. Locate the configuration box for the device to which you want to upload a saved .xml file.

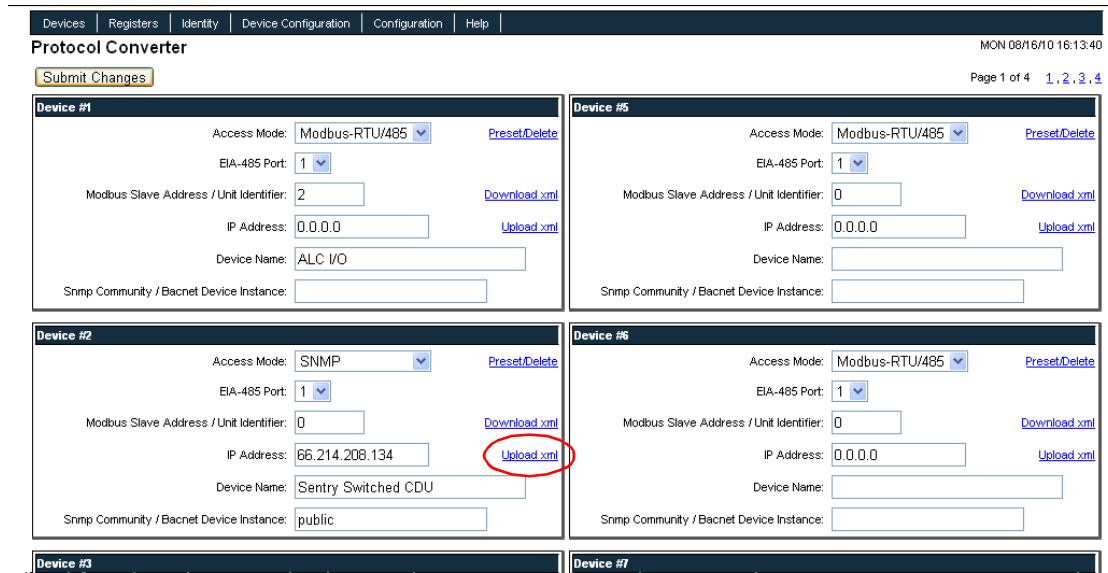

Figure A.12 Device Configuration Web Page

- 3 Click the Upload XML link in that device’s configuration box.

The XML Upload dialog displays in a secondary browser window.

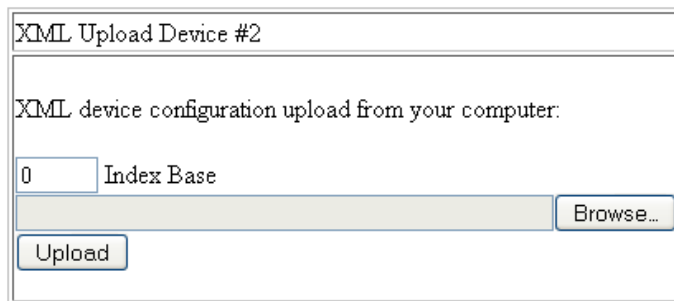

Figure A.13 XML Upload Dialog

- 4 Browse for the .xml file you saved. Select the file, then in the Index Base box, indicate the index (register) number you want to start from when the upload occurs.

5 Click Upload.

One of three message displays:

- ◆ XML file upload complete.
- ◆ XML file cannot be upload - index base was not specified. If this occurs, retry the operation and specify a register number in the Index Base box.
- ◆ File has been uploaded - but type is unknown. Proceed to step 6.

6 If you want to revert to the preset registers or delete all registers, or if you attempted to upload an unknown file type to a device, click the Preset/Delete link for that device.

Figure A.14 Preset/Delete Link on Device Configuration Webpage

7 The Preset/Delete dialog displays in a secondary browser window.

Figure A.15 Preset/Delete Dialog

8 Select one of two items from the drop-down:

Figure A.16 Drop-Down for Preset/Delete Dialog

9 Revert to the preset registers or delete all register information as follows:

- ◆ To revert to the preset values, indicate a Start Index number. This is the number of the register at which you want to begin the preset operation.

If you choose to preset the register values, the following message displays when the operation is complete:

```
8036 registers preset at index 1
```

- ◆ If you choose Delete Device/Registers, all device information will be deleted. **Use this option with caution.**

You do not need to enter a Start Index number when deleting all registers.

If you choose the delete option, the following message displays when the operation is complete:

```
Device and Registers deleted
```

B

TROUBLESHOOTING

Problem	Action
Control Panel will not Power Up	<ol style="list-style-type: none"><li data-bbox="768 894 1471 1031">1 Check with a DVM (Digital Volt Meter) for AC or DC input power on the lower left hand terminal block on the Protocol Converter. If no voltage is present at terminal block, check the circuit breaker or power supply that powers the Protocol Converter.<li data-bbox="768 1041 1471 1096">2 If voltage is present contact RLE Technologies for further troubleshooting.

Table B.1 Troubleshooting the Protocol Converter

Problem	Action
Unable to see the web page	<ol style="list-style-type: none"> <li data-bbox="724 249 1412 380">1 Verify that the Protocol Converter is powered up and running. You will see lights on the RJ45 (Ethernet) port illuminated and flashing. If no lights are illuminated on the unit, check for power to the unit. If lights are illuminated and flashing, go to step 2. <li data-bbox="724 405 1412 640">2 Connect a serial cable up to the Protocol Converter console port. Once connect and your terminal emulation program is running, type ip and then press enter, this will display the current IP address set to the unit. Verify it is the correct address. The same can be done for viewing the Net Mask number by entering nm and then press enter. For viewing the Default Gateway type dg and then press enter. Correct any information that is wrong. If the information is correct, go to step 3. <li data-bbox="724 665 1412 957">3 With the serial cable connected and your terminal emulation program open, you can enter an address to have the Protocol Converter ping to. Get a known good address and the type ping <one space> ip address and then press enter. Example: ping 192.168.1.1, if a ping response is not established, get with the IT department and make sure the patch cord being used is good, and then have the network switch port checked to make sure it is activated. If a ping response is established, call your local sales representative or RLE Technologies technical support department.
Slave units are showing loss of communication.	<ol style="list-style-type: none"> <li data-bbox="724 978 1412 1052">1 Check the Device Configuration in the Protocol Converter and make sure the proper addressing is assigned. <ol style="list-style-type: none"> <li data-bbox="756 1077 1412 1157">a Modbus-RTU/485: The device address is set to the proper RTU address and the 485 communications line is wired properly. <li data-bbox="756 1182 1412 1312">b Modbus TCP/IP: The Proper device address and IP address has been assigned. Modbus TCP/IP communications requires port 502 of that IP address to be enabled/open. Check with IT to make sure there is not a firewall or port blocking on port 502. <li data-bbox="756 1337 1412 1467">c SNMP: Check the IP address and community that was configured on the Protocol Converter for communication. Port 161 of the IP address is used for SNMP get data. Check to make sure this port is open. <li data-bbox="756 1493 1412 1598">d BACnet: Check the IP address and device number configured on the Protocol Converter. The default port used for BACnet data is port 47808. Check with IT to make sure this port is open for communication on the network.

Table B.1 Troubleshooting the Protocol Converter (continued)



TECHNICAL SPECIFICATIONS

Table C.1 Technical Specifications

Power	24VAC @ 600mA max, 50/60Hz, 24VDC @ 600mA max.	
Communications Ports		
	Ethernet	10/100 BASE-T, RJ45 connector; 500VAC RMS isolation
	EIA-232	DB9 female connector; 9600 baud; No parity, 8 data bits, 1 stop bit
	EIA-485 (Dual Port Protocol Converter contains 3 EIA-485 ports)	1200, 2400, 9600 or 19200 baud (selectable); Parity: none, even or odd, 8 data bits, 1 stop bit. Port 2 is configurable for half-duplex (2-wire) or full-duplex (4-wire)
Protocols		
	TCP/IP, HTML, TFTP, SNMP	V1: V2C MIB-2 compliant; NMS Manageable with Get
	Modbus (EIA-485)	Modbus Master/Slave; RTU mode; Supports Master codes 01, 02, 03, 04 and Slave code 03
	Modbus TCP/IP UDP/IP	Modbus Master/Slave; TCP/IP transmission protocol
	BACnet/IP	ASHRAE STD 135-2004 Annex J; Port 3 of Dual Port Protocol Converter is BACnet MS/TP capable (Slave only)
	SMTP (email)	Supports Client Authentication (plain and login); compatible with ESMTP servers
	Terminal Emulation	VT100 compatible (for configuration and diagnostics only)
Protocols In	SNMP, Modbus TCP/IP & RTU, BACnet	
Protocols Out	SNMP, Modbus TCP/IP & RTU, BACnet; BACnet MS/TP (Port 3 of Dual Port Protocol Converter only)	
Login Security		
	Web Browser Access (Ethernet)	1 Web password Read Only; 1 Web password Read/Write
	Terminal Emulation Access	None
Maximum Number of Units/Modules/Nodes	32	

Table C.1 Technical Specifications (continued)

Maximum Number of Registers/OIDs/ Instances	1,024
Indicators	
Status	1 Red: flashing=boot-up sequence; solid=alarm condition
EIA-485 Transmit and Receive	1 Green Transmit; 1 Green Receive (additional LEDs for Dual Port Protocol Converter)
Operating Environment	
Temperature	32°F to 122°F (0°C to 50°C)
Humidity	5% to 95% RH (non-condensing)
Altitude	15,000ft (4572m) max.
Storage Temperature	-4°F to 185°F (-20°C to 85°C)
Mounting	Desktop or 19" (48.26cm) rack mount
Dimensions	9.8"W x 5.3"D x 1.8"H (248mmW x 135mmD x 46mmH)
Weight	2.32.lb (1.05kg)
Certifications	CE; ETL listed: conforms to UL STD 61010-1, EN STD 61010-1; certified to CSA C22.2 STD NO. 61010-1; RoHS compliant