



LD5200

User Guide

User Guide Version 04.22
Documented Using Firmware Version 2.3.1



Copyright and Trademark Notices

© Raymond & Lae Engineering, Inc. 2012. All rights reserved. RLE® is a registered trademark and SeaHawk™, Falcon™, and Raptor™ are trademarks of Raymond & Lae Engineering, Inc. The products sold by Raymond & Lae Engineering, Inc. are subject to the limited warranty, limited liability, and other terms and conditions of sale set forth at <http://www.rletech.com/>.

Revision History

Rev. No.	Date	Rev. No.	Date
1.0	April 2011	2.7	May 2018
2.0	April 2012	2.8	May 2018
2.1	May 2012	2.9	June 2019
2.2	July 2013	03.21	March 2021
2.3	April 2014	04.22	April 2022
2.4	September 2015		
2.5	November 2016		
2.6	December 2016		

Manufacturer's Notes

This product is manufactured by RLE Technologies, 104 Racquette Drive, Fort Collins, CO, 80524.

If this product is used in any manner other than that specified by the manufacturer, the protection provided by the equipment may be impaired.

Product Warranty

Warranty information for RLE products can be found at www.rletech.com.

Product Registration

Product registration helps RLE Technologies inform owners of:

- Product upgrades
- Firmware enhancements
- New products and technologies
- Special offers available only to registered users

Any information provided to RLE Technologies through the registration form will be regarded as confidential. RLE will not sell or distribute any of the information to third parties.

Technical Support

Before you install an LD5200, refer to RLE Technologies' website, www.rletech.com, to ensure you are using the most recent version of all documentation.

Personal assistance is available Monday through Friday, from 8:00 a.m. to 5:00 p.m. MST.

A request for assistance may be sent to support@rletech.com. You can also call us at: **800-518-1519**.

The following information is located on the bottom of each LD5200 unit. Please have this information available whenever a technical support call is placed:

Product Model Number _____
Product Serial Number _____
Product Manufacture Date _____

The LD5200 is not a field-serviceable item and must be sent back to RLE Technologies for mechanical repair. Power must be disconnected (unplugged) from the LD5200 any time the unit is mechanically serviced. Physically unplug power from the unit any time you are making wiring connections to or from the LD5200.

RLE cannot accept an item for repair without a Return Materials Authorization number, which must be provided by RLE.

Contents

1	Product Overview	13
	Description	13
	Operation	13
	Supervised System	13
	Distance-Read Leak Detection	14
	User Configuration and Communication	14
2	Installation	15
	Prepare for Installation	15
	Mount the LD5200	16
	Establish Physical Connections	16
	TB1: 4-20mA Output	18
	TB2: Sensing Cable Interface	18
	TB3: Maintenance Relay	18
	TB4: Two Fault/Leak Relay Outputs	18
	P1: EIA-232 Connector	19
	SW1: TB5 Port 3 Termination Switch	19
	TB5 and TB6: EIA-485 Modbus Ports	19
	SW2: TB6 Port 2 (Bottom Row) Termination Switch	20
	SW3: TB6 Port 1 (Top Row) Termination Switch	20
	P2: RJ45 Network	20
	P3: Optional Power Connection	20
	TB7: Input Power (from Input AC Power Supply)	20
	DS1: Status LED	20
	Connect the SeaHawk Sensing Cable	21
	Connect Lengths of Sensing Cable	21
	Secure Sensing Cable to the Floor	21
	Apply Power to the LD5200	22
	Configure Communications	23
	Access the Configuration Menu	23
	Test the System	24
	Calibrate Cable Resistance	25
	Configure Security Settings	27
	General Operation	27
3	LCD Touch Screen Interface	29
	Main Menu	30
	Silence Button	30
	Alarms Button	31
	History	32
	Status Button	33
	System Button	35
	Setup Button	36
	Leak Settings	37
	Virtual Zone	40
	Slave Zone	41
	4-20mA Output	42

Preventative Maintenance	43
System Settings	44
EIA-485 / Modbus / N2	45
Bacnet	46
Clear History	46
4 Web Interface	47
Home Page	47
Identity	48
Configuration	49
Leak	50
Virtual Zone	55
Slave Controller	56
Slave Zones	57
Network/IP	58
Network Statistics	59
Web	60
Map	61
Upload the Map Image	64
Map Reference Points	65
Test the Mapped Coordinates	67
Viewing the Map	70
Clock	70
NTP	71
Email-SMTP/DNS	73
SNMP/Syslog	75
EIA-485 Port/Modbus/N2	78
Bacnet	80
Alarm Management	82
System/Flash Management	83
Product Registration	83
Historical Data	84
Refresh	86
5 Modbus Communication	87
Comm Port Settings	87
Leak Detection Modbus Master	87
Connect Distance Read Panels to the LD5200	87
Implementation Basics	88
Modes of Transmission	88
Slave Address Field	88
Function Field	88
Data Field	88
Error Check (Checksum) Field	89
Packet Communications For The LD5200	89
Function 03: Read Output Registers	89
Function 04: Read Input Registers	91
Function 06: Preset Single Register	101
Function 16: Preset Multiple Registers	101
RTU Framing	102
A Update Firmware	103
Update the LD5200 Firmware	103
B EIA-232 Interface	105
Set the IP Address through the EIA-232 Port	105
Boot Up	106

	Main Menu	106
	Other Main Menu Functions	107
C	Preventive Maintenance	109
D	Troubleshooting	111
	Troubleshooting Problems with the LD5200	111
	Troubleshooting Sensing Cable	114
E	4-20mA Output Testing	117
F	Technical Specifications	119

Figures

1	Product Overview	13
2	Installation	15
	Figure 2.1 LD5200 Wall Mounting Kit	16
	Figure 2.2 LD5200 Physical Connections and Switches	17
	Figure 2.3 Cable Connection TB2	18
	Figure 2.4 SeaHawk Sensing Cable	21
	Figure 2.5 Secure the Cable	22
	Figure 2.6 Apply Moisture to the Cable for Testing Purposes	24
3	LCD Touch Screen Interface	29
4	Web Interface	47
	Figure 4.1 LD5200 Web Interface Home Page	47
	Figure 4.2 LD5200 Web Interface Home Page with Active Leak Detected Alarm	48
	Figure 4.3 Identity Page	48
	Figure 4.4 Configuration Page	49
	Figure 4.5 Leak Configuration Page	50
	Figure 4.6 Virtual Zone Configuration Page	55
	Figure 4.7 Slave Controller Configuration Page	56
	Figure 4.8 Slave Zone Configuration Page, Distance-Read via Modbus	57
	Figure 4.9 Slave Zone Configuration Page, Zone	57
	Figure 4.10 Network/IP Configuration Page	58
	Figure 4.11 Network Statistics Page	59
	Figure 4.12 Web Configuration Page	60
	Figure 4.13 Leak Detection Reference Map	61
	Figure 4.14 Map Settings Page	62
	Figure 4.15 Map Configuration Page	65
	Figure 4.16 Map Image Upload Message	65
	Figure 4.17 Map Image Upload Error Message	65
	Figure 4.18 Mapping Crosshairs - Reference Point	66
	Figure 4.19 Map Key	66
	Figure 4.20 Graphical Mapping Link	66
	Figure 4.21 Mark the Beginning of the Cable Run	67
	Figure 4.22 Crosshairs Designate the Mapped Coordinate	67
	Figure 4.23 Coordinates Have Been Mapped - Return to the Map Configuration Page	67
	Figure 4.24 Click the Map Alarm Test Link to View All Mapped Points in an Alarm State	68
	Figure 4.25 Map (Image) Buttons on Home Page	70
	Figure 4.26 Clock Configuration Page	70
	Figure 4.27 NTP Configuration Page	71
	Figure 4.28 Email-SMTP/DNS Configuration Page	73
	Figure 4.29 SNMP/Syslog Page	75
	Figure 4.30 Modbus EIA-485 Page	78
	Figure 4.31 Bacnet Page	81

Figure 4.32	Alarm Management Page	82
Figure 4.33	System/Flash Management Page	83
Figure 4.34	Historical Data Page	84
Figure 4.35	Alarm History Text File (.txt)	85
Figure 4.36	Trend Log	86
5	Modbus Communication	87
Figure 5.1	LD5200 Connection Diagram	88
A	Update Firmware	103
Figure A.1	System/Flash Management Page	103
Figure A.2	Choose the Firmware File	104
Figure A.3	Firmware Load Message	104
B	EIA-232 Interface	105
Figure B.1	EIA-232 Main Menu Screen	106
C	Preventive Maintenance	109
D	Troubleshooting	111
E	4-20mA Output Testing	117
Figure E.1	4-20mA Testing	117
F	Technical Specifications	119

Tables

1	Product Overview	13
2	Installation	15
3	LCD Touch Screen Interface	29
Table 3.1	LCD - Main Buttons	29
Table 3.2	LCD Main Menu Buttons	30
Table 3.3	LCD Current Alarm Color Codes	31
Table 3.4	LCD Current Alarm Buttons	31
Table 3.5	LCD Alarm History Color Codes	32
Table 3.6	LCD Alarm History Buttons	32
Table 3.7	LCD Controller Status Information Fields	33
Table 3.8	LCD Controller Status Buttons	34
Table 3.9	LCD System Status Button Options	35
Table 3.10	LCD Leak Settings - Configurable Options	37
Table 3.11	LCD Virtual Zone Settings - Configurable Options	40
Table 3.12	LCD Slave Zones Setup - Configurable Options	41
Table 3.13	LCD 4-20mA Settings - Configurable Options	42
Table 3.14	LCD Preventative Maintenance - Configurable Options	43
Table 3.15	LCD System Settings - Configurable Options	44
Table 3.16	LCD EIA-485 / Modbus / N2 Setup - Configurable Options	45
Table 3.17	LCD Bacnet Setup - Configurable Options	46
4	Web Interface	47
Table 4.1	Leak Configuration Options	51
Table 4.2	Virtual Zone Configuration Options	55
Table 4.3	Slave Controller Configuration Options	56
Table 4.4	LDZ/Slave Zone Label Configuration Options	57
Table 4.5	Network/IP Configuration Options	58
Table 4.6	Web Configuration Options	60
Table 4.7	Map Settings Options	62
Table 4.8	Clock Configuration Options	70
Table 4.9	NTP Configuration Options	71
Table 4.10	Email-SMTP/DNS Configuration Options	73
Table 4.11	SNMP/Syslog Options	75
Table 4.12	Modbus/EIA-485 Options	78
Table 4.13	Bacnet Options	81
Table 4.14	Alarm Management Options	82
Table 4.15	System/Flash Management Options	83
Table 4.16	Historical Data Options	84
Table 4.17	Alarm History Log Description	85
5	Modbus Communication	87
Table 5.1	Exception Codes	89

Table 5.2	Read Output Registers Packet Structure	89
Table 5.3	Output Registers	90
Table 5.4	Read Input Registers Packet Structure	91
Table 5.5	Input Registers	92
Table 5.6	Status Flags (Registers 30010 and 30011)	100
Table 5.7	Status Flags (Register 30013 - 30273)	100
Table 5.8	Preset Single Register Packet Structure	101
Table 5.9	Preset Multiple Registers Packet Structure	101
Table 5.10	Query Sample	102
Table 5.11	Response Sample	102
A	Update Firmware	103
B	EIA-232 Interface	105
Table B.1	Other Main Menu Functions	107
C	Preventive Maintenance	109
D	Troubleshooting	111
Table D.1	Troubleshoot Problems with the LD5200	111
Table D.2	Troubleshoot Sensing Cable	114
E	4-20mA Output Testing	117
F	Technical Specifications	119
Table F.1	Technical Specifications	119

CHAPTER

1

PRODUCT OVERVIEW

1.1 Description

The LD5200 is a distance-read leak detection controller. It can operate as a stand-alone device or connect to multiple RLE leak detection controllers through its Ethernet or EIA-485 ports. When coupled with up to 10,000 feet (3084m) of RLE's sensing cable, it reports the presence of water and other conductive liquids. When a conductive liquid comes in contact with the sensing cable, the following occurs:

- ◆ An audible alarm sounds.
- ◆ The distance to the leak is shown on the LD5200's LCD touch screen and on the LD5200's web interface. An integrated reference map within the web interface will also show the location of the leak.
- ◆ Notification is sent via email or Modbus/SNMP/BACnet/SMTP to a central control location, such as a building management system (BMS).

1.2 Operation

1.2.1 Supervised System

The LD5200 is a *supervised system* - it continually monitors sensing cable, spot detectors, and connected leak detection controllers for continuity and produces alarms for the following conditions:

- ◆ Leak detection
- ◆ Cable break
- ◆ Cable contamination
- ◆ Loss of communications

1.2.2 Distance-Read Leak Detection

When the LD5200's circuitry measures a current in excess of the user-defined leak threshold, the unit's microprocessor computes the distance to the leak. The LD5200 then annunciates the leak and logs the alarm in its event log. The leak is communicated via email/Modbus/SNMP/BACnet/SMTP/4-20mA to an equipped monitoring system. The relay output sends notification to an alarm panel or monitoring system.

1.2.3 User Configuration and Communication

All the functionality needed to operate the LD5200 as a stand-alone device is accessible from the LCD touch screen. Virtual buttons line the right side of the screen. Press the button for the task you want to perform, and the screen for that task is displayed. Avoid using a pen or other sharp object to activate the buttons on the LCD. This will damage the display.

The web-based user interface provides more extensive configuration options and allows users to create an interactive map - a graphical representation of the monitored environment and leak detection equipment. This web interface can be used on site or remotely via network communications.

Digital fault and leak relay outputs and a 4-20mA relay output and allow the LD5200 to interface with third-party management systems. The LD5200 also provides Modbus outputs via EIA-485, twisted-pair wire, or TCP/IP, as well as BACnet/IP or BACnet/MSTP, SNMP, and SMTP outputs.

INSTALLATION

2.1 Prepare for Installation

Before you install or troubleshoot equipment, always check the RLE website first to ensure you're working with the most recent version of our documentation.

To install the LD5200, you'll need the following supplies:

Included with the LD5200

- ◆ Wall mount kit
- ◆ 15 foot (4.57m) leader cable
- ◆ End-of-line terminator (EOL)

Available from RLE, sold separately

- ◆ SeaHawk sensing cable
- ◆ Non-sensing cable, other accessories

Additional Supplies and Information Required

- ◆ Crossover network cable

Consult with your IT administrator to determine the following network settings for the LD5200:

- ◆ IP address
- ◆ Subnet mask
- ◆ Default gateway

2.2 Mount the LD5200

The LD5200 is a wall mounted device. Using the wall mount kit (included), mount the device in a convenient location.



Figure 2.1 LD5200 Wall Mounting Kit

Once the unit is mounted on the wall, run conduit to the device to support your cabling needs.

2.3 Establish Physical Connections

The connectors for the LD5200 are accessible from the inside of the enclosure. Remove the knock-outs on the bottom and top of the enclosure as necessary to accommodate conduit and cabling.

The LD5200 is built with two circuit boards:

- ◆ The **display board** is mounted on the inside of the LD5200's door, and is connected to the main board with a multi-wire connector. The display is a color touch screen that enables configuration and management from the front panel.
- ◆ The **main board** is mounted inside the main compartment of the enclosure. A power supply and power switch are also mounted in this main compartment.

The connectors on the main board, shown in [Figure 2.2](#), are labeled TB1 through TB7 and P1 through P3. Switches are labeled SW1 through SW3 and the Status LED is labeled DS1. The image of the board has been rotated to accommodate labels.

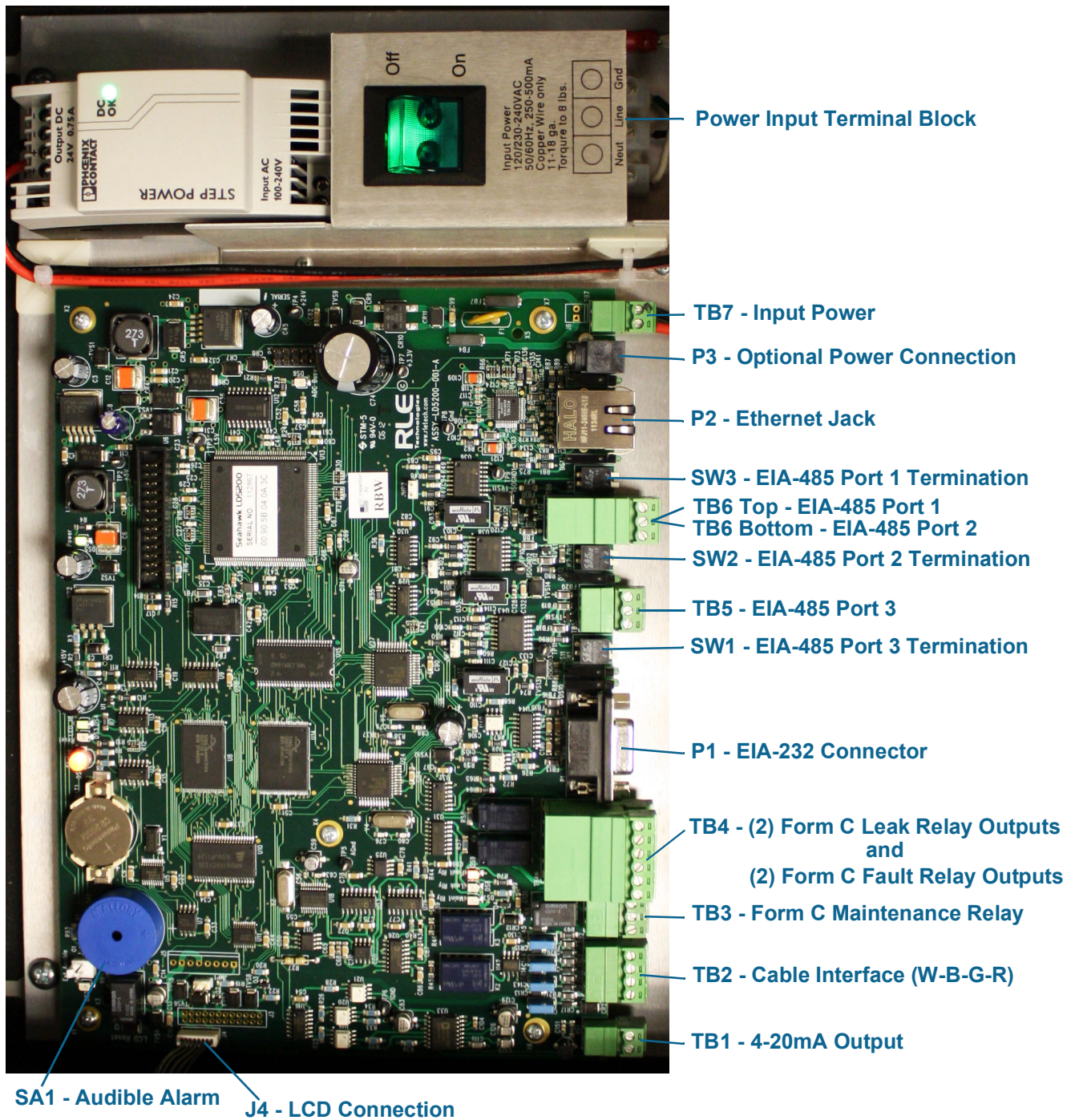

Figure 2.2 LD5200 Physical Connections and Switches

2.3.1 TB1: 4-20mA Output

The 4-20mA analog output allows the LD5200 to communicate with a 4-20mA loop powered output. This connection is provided on TB1. The maximum range (20 mA) can be set to 1000, 2500, 5000, 7500, or 10,000 feet. Connect the 4-20mA wires to TB1 as follows:

- TB1-1 4-20mA positive (+)
- TB1-2 4-20mA negative (-)

2.3.2 TB2: Sensing Cable Interface

A 15-foot (4.57m) section of non-sensing cable is supplied with each LD5200. The leader cable connects sensing cable to the LD5200, since sensing cable cannot connect directly to the unit. Insert its four stripped wires into the appropriate slots in TB2 - from left to right: white, black, green and red.

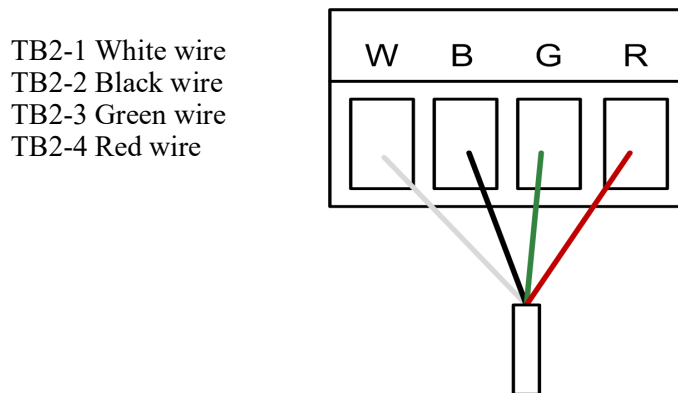

Figure 2.3 Cable Connection TB2

NOTE If the terminal connector is removed from the end of the cable, make sure the wires are in the same order, W - B - G - R, when the connector is reapplied.

For further information regarding sensing cable, refer to [“Connect the SeaHawk Sensing Cable”](#) on page 21.

2.3.3 TB3: Maintenance Relay

Maintenance reminders can be configured through the LCD or the web interface. This relay (TB3) is activated once the scheduled maintenance period has lapsed. If you wish, connect this relay output to a BMS or NMS to monitor regularly scheduled maintenance intervals.

2.3.4 TB4: Two Fault/Leak Relay Outputs

TB4 houses two Form C relay outputs. These relays provide alarm notification when a leak, cable fault, or cable contamination is detected.

The top row of TB4 (pins 1 - 6) provides a connection to one of the leak alarm relay outputs and one of the fault relay outputs; the bottom row of TB5 (pins 7 - 12) provides a second set of contacts for the same leak and fault alarms.

Connect the alarm relay wires to TB4 as follows:

TB4-1 Leak alarm normally open (NO)
 TB4-2 Leak alarm common (C)
 TB4-3 Leak alarm normally closed (NC)
 TB4-4 Fault alarm normally open (NO)
 TB4-5 Fault alarm common (C)
 TB4-6 Fault alarm normally closed (NC)

TB4-7 Leak alarm normally open (NO)
 TB4-8 Leak alarm common (C)
 TB4-9 Leak alarm normally closed (NC)
 TB4-10 Fault alarm normally open (NO)
 TB4-11 Fault alarm common (C)
 TB4-12 Fault alarm normally closed (NC)

Both relays (all alarms) can be configured to be latched or unlatched. A latched alarm requires a manual reset of the system once a leak or cable problem is no longer present; see [“Leak” on page 50](#) for configuration instructions.

2.3.5 P1: EIA-232 Connector

An EIA-232 connection allows the LD5200 to be connected directly to a terminal or PC. The EIA-232 uses a baud rate of 9600. The EIA-232 port is set to 8 databits, no parity, and 1 stop bit (8, N, 1). A straight through cable should be used to connect a terminal or PC to the LD5200 via the EIA-232 connector. This connection should only be used by advanced users for specialized operations, including advanced diagnostics, uploading firmware, and troubleshooting.

2.3.6 SW1: TB5 Port 3 Termination Switch

The switch position numbered 2 on SW1, when switched on (down position), places a termination resistor across the + and - terminals of the EIA-485 port. This is used when the TB5 connection on the LD5200 is the last unit on a EIA-485 network. SW1, switch position 1, is currently inactive.

2.3.7 TB5 and TB6: EIA-485 Modbus Ports

TB5 and TB6 connect to an EIA-485 network. A grounded shield contact is provided for connection to shielded cable. If the shield contact is used, verify the power connector is properly grounded and there is no voltage potential between units on the network. The EIA-485 ports have a selectable baud rate (9600, 19200, or 38400) and are set to 8 databits, no parity, and 1 stop bit (8, N, 1). Connect the EIA-485 wires to TB5 and TB6 as follows:

TB5, EIA-485 port 3
 TB5-1 A (+)
 TB5-2 B (-)
 TB5-3 Shield

TB6 (top row) EIA-485 port 1
 TB6-1 A (+)
 TB6-2 B (-)
 TB6-3 Shield

TB6 (bottom row) EIA-485 port 2
 TB6-4 A (+)
 TB6-5 B (-)
 TB6-6 Shield

2.3.8 SW2: TB6 Port 2 (Bottom Row) Termination Switch

The switch position numbered 2 on SW2, when switched on (down position), places a termination resistor across the + and - terminals of the EIA-485 port. This is used when the TB6 (bottom row) connection on the LD5200 is the last unit on a EIA-485 network. SW2, switch position 1, is currently inactive.

2.3.9 SW3: TB6 Port 1 (Top Row) Termination Switch

The switch position numbered 2 on SW3, when switched on (down position), places a termination resistor across the + and - terminals of the EIA-485 port. This is used when the TB6 (top row) connection on the LD5200 is the last unit on a EIA-485 network. SW3, switch position 1, is currently inactive.

2.3.10 P2: RJ45 Network

This 10/100 BaseT Ethernet connection allows the LD5200 to be connected directly to a local area network. Use a crossover cable for initial connection and configuration. The default settings are as follows:

IP Address: 10.0.0.188
 Subnet Mask: 255.255.255.0
 Default Gateway: 10.0.0.1

2.3.11 P3: Optional Power Connection

If a mechanical failure causes the provided AC power supply and connections to fail, a wall adapter can be plugged into P3 and used to power the LD5200. This option is provided for temporary, emergency situations only, and is not intended as a permanent power solution.

2.3.12 TB7: Input Power (from Input AC Power Supply)

TB7 is a factory-wired two position connector with the following connections (for reference only):

TB7-1 24VDC positive (+)
 TB7-2 24VDC negative (-)

2.3.13 DS1: Status LED

A status LED is located at the top of the main board, and is labeled DS1. Indicators are as follows:

Green - LD5200 is functioning properly
 Red - LD5200 is in an alarm state
 Yellow (flashing) - The LD5200's bootloader is operational

2.4 Connect the SeaHawk Sensing Cable

IMPORTANT To avoid faulty leak detection readings, connect a minimum length of 35 feet (10.7m) of sensing cable to the LD5200.

The LD5200 is shipped with a 15-foot (4.57m) leader cable. This leader cable was connected to the LD5200 in [Section 2.3.2 on page 18](#). The following directions will help you connect sensing cable to the LD5200.

2.4.1 Connect Lengths of Sensing Cable

- 1 Unscrew the end-of-line (EOL) terminator from the end of the leader cable.
- 2 Attach the first length of sensing cable to the leader cable. Insert the male connector into the female connector, and twist the collar on the female side of the connector to secure.

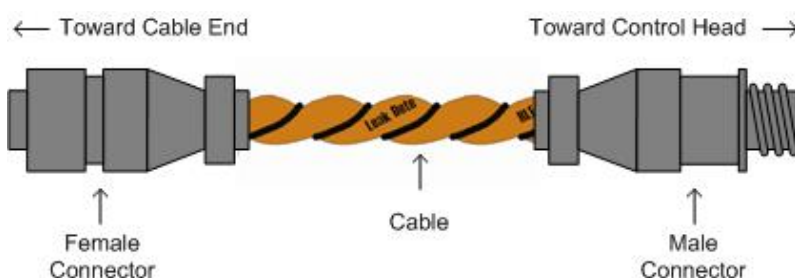

Figure 2.4 SeaHawk Sensing Cable

- 3 Route the sensing cable according to your cable layout diagram. Attach additional lengths of sensing cable as necessary.
- 4 Secure the EOL terminator to the unoccupied end of the last length of sensing cable.

Note If the EOL terminator is not present at the end of the cable run, a cable fault will register.

- 5 If you are using a reference map, compare it with the actual cable installation. Revise any discrepancies created through the physical installation of the cable.

2.4.2 Secure Sensing Cable to the Floor

Secure the sensing cable to the floor with either J-clips (RLE part #JC), or one of the other approved methods shown in [Figure 2.5](#). Available from RLE and designed specifically for use with sensing cable, J-clips are the manufacturer's recommended installation method.

- ◆ Do not use conductive materials, such as Fire Block or caulk, on the sensing cable.
- ◆ To avoid contaminating the cable, clean the entire floor as much as possible. Use isopropyl alcohol to clean the spots on the floor where J-clips will be placed.
- ◆ Place one J-clip every 5 to 6 feet (1.52 to 1.83m) along the length of the sensing cable and one at each turn of the cable. Use more J-clips if a tighter configuration is required.
- ◆ If the cable is installed over an obstruction, clip the cable on both sides, as close to the obstruction as possible.

- ◆ The J-clip's adhesive backing does not work well on porous concrete floors. RLE recommends using a drop of silicone or another nonconductive adhesive to help secure the J-clip to the floor.

IMPORTANT Do not install the cable directly in front of an air conditioner. Allow a minimum of 4 to 6 feet (1.22 to 1.83m) between the unit and the cable. If the cable is too close to the air conditioning unit's air stream, the moisture from the humidifier may cause false leak readings. If the cable must be installed in front of an air conditioning unit, place the J-clips 3 feet (0.91m) apart.

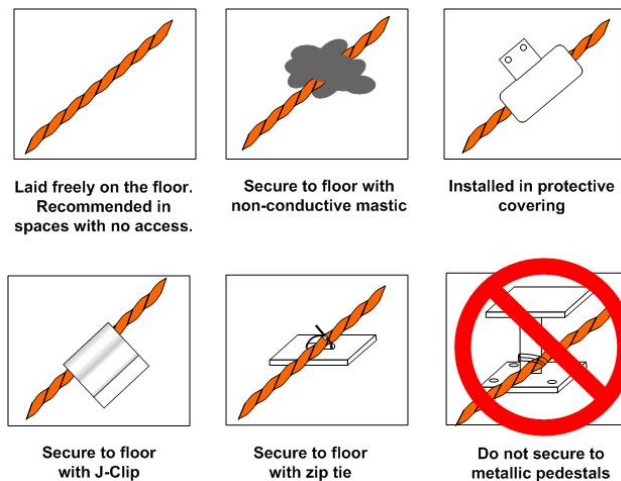

Figure 2.5 Secure the Cable

2.5 Apply Power to the LD5200



WARNING

A dedicated circuit breaker must be provided within close proximity to the LD5200 and be clearly marked as the disconnecting device for the LD5200 leak detection controller.

Do not connect 120/230 VAC directly to the unit, or damage will occur to the circuitry.

Make sure the dedicated circuit breaker is in the off position before connecting the AC power wires to the LD5200.

- 1 Engage a certified electrician to run a power supply and necessary conduit to the location of the LD5200.
- 2 Remove any necessary knock-outs from the bottom of the enclosure, and route the power supply into the enclosure, to the power input terminal block. Insert the wires as noted on the enclosure's backplate: Neutral - Line - Ground. Ensure all connections are correct and all screw terminals are tightened and secure.
- 3 Apply power to the LD5200. The device will boot (initialize).

- 4 When the LD5200 powers up, diagnostics are performed. The program code is verified. Once the diagnostics are complete, the LCD displays the Main Menu. No alarm should be present. If an alarm is present, verify all connections and consult Appendix D, “Troubleshooting” on page 111.

2.6 Configure Communications

Use the LCD touch screen on the front of the LD5200 to configure communications.

IMPORTANT Consult your IT department before performing these steps. If you intend to change the IP Address and/or Subnet Mask, obtain appropriate addresses from your IT department.

LD5200 default IP address: 10.0.0.188

LD5200 default subnet mask: 255.255.255.0

LD5200 default gateway: 10.0.0.1

2.6.1 Access the Configuration Menu

- 1 Push the Setup button on the LD5200’s LCD.
- 2 You’ll be prompted to enter a password. By default, there is no password on the LD5200. To continue past the login screen, leave the password field blank and press the Enter button ().

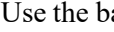
You can establish an LCD password through either the LCD interface (“Leak Settings” on page 37) or the web interface (Chapter 4, “Leak” on page 50).
- 3 You’ll see the LD5200 Setup Menu. Press the Down button until the System Settings option is highlighted in blue. Press the Select button to access the System Setup Menu.
- 4 Push the Down button until the IP address is highlighted. By default, the IP address is 10.0.0.188. Press the Select button to change the IP address.
- 5 Use the backspace button () to delete the current IP address. Enter the new IP address for the unit, as provided by your Network Administrator. Press the Enter button to apply the new IP Address.
- 6 Scroll down to the Net Mask, and use the same method to edit the Subnet Mask information as necessary.

2.7 Test the System

Note If the LD5200 is already connected to a BMS or NMS, notify monitoring personnel before you begin testing the system.

- 1 Using a sketch or mechanical drawing of the facility, add the cable routing, connection points, and any accessories used. Record the distance marker when the cable changes direction and in between connectors.

The more details you show, the greater the benefit later when you are locating leaks and troubleshooting the system

- 2 To verify the LD5200's accuracy, test three points within the length of sensing cable - one at the beginning, one in the middle of the length, and another near the end of the length of cable.

There are a variety of ways to simulate a leak:

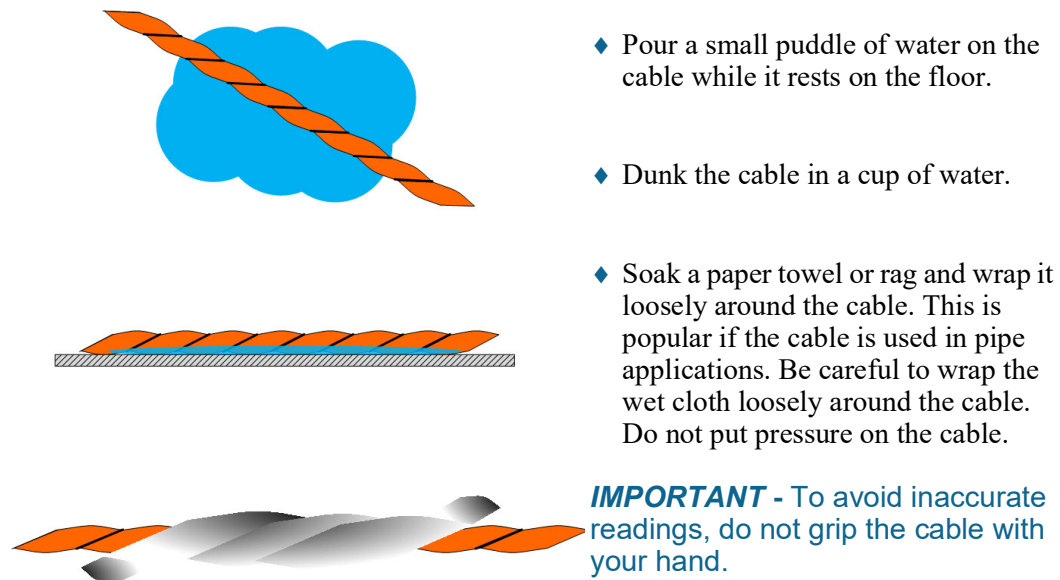

Figure 2.6 Apply Moisture to the Cable for Testing Purposes

- 3 Verify that the LD5200 reports the leaks within a few feet of their actual physical location.
- 4 Remove the simulated leak source and return the system to its normal operating state.

2.8 Calibrate Cable Resistance

Distance-read leak detection systems are resistance-based. RLE's sensing cables have a base resistance of 2.8 ohms/foot. The resistance of each length of sensing cable may be slightly more or less than the base resistance due to manufacturing variances. For this reason, the cable length displayed on the home page of the web interface and on the status screen of the LCD may be slightly more or less than the actual length of cable installed.

A system configured using base resistance values will still be very accurate. If you wish to fine tune the resistance value of your LD5200 system to make it more precise, you may do so. This will increase the accuracy of the system, and bring the LD5200's reported installed cable length value in line with the actual length of cable installed.

- 1 Ensure the LD5200 has been powered and has all the sensing cable attached to it, with no alarms present.
- 2 Gather and record the following data from either the home page of the web interface or the status page of the LCD:

Cable Length (as reported by the LD5200)	
Cable Current	
Leg 1 Resistance	
Leg 2 Resistance	

Record the resistance per foot setting, as reported by the LD5200. This can be found on the Leak Configuration page of the web interface (Configuration > Leak Settings) or on the Leak Settings screen of the LCD (Setup > Leak Settings).

Reported Resistance per Foot	
------------------------------	--

- 3 Note the actual (physical + simulated) length of cable physically connected to the system. For your reference:
 - ◆ WCCS simulates 50 ft.
 - ◆ SDZ simulates 50 ft.
 - ◆ XCON simulates 150 ft.
 - ◆ Nonsensing cable does not add any length to a system

Record this sum:

Actual length of cable connected to LD5200	
--------------------------------------------	--

- 4 Verify the current reading on the cable from your recorded values above. This value must be less than 15 μ A in order to calibrate the system. If the current is higher than 15 μ A, clean the cable. Isopropyl alcohol works well to remove any contamination that might have gotten onto the cable during installation.
- 5 To calculate the most accurate resistance value for the system, divide the reported cable length by the actual cable length, and multiply the quotient by the reported resistance.

$$\left(\frac{\text{Reported Cable Length}}{\text{Actual Cable Length}} \right) \times \text{Reported Resistance} = \text{New Resistance}$$

For example:

Cable Length (as reported by the LD5200)	391 feet
Cable Current	0 μ A
Leg 1 Resistance	1088 Ohms
Leg 2 Resistance	1095 Ohms
Reported Resistance	2.800 Ohms/foot

One 15 foot leader cable (leader cable does not count toward the total length of cable installed), one weighted cable connector (simulates 50 feet of cable), and one 330 foot section of cable are connected to the system.

Actual length of cable connected to LD5200	380 feet
0 feet + 50 feet + 330 feet	

$$\left(\frac{391 \text{ feet}}{380 \text{ feet}} \right) \times 2.800 \text{ Ohms} = 2.881 \text{ Ohms/foot}$$

The actual resistance of the cable installed with this LD5200 is 2.881 ohms per foot.

- 6 Replace the resistance per foot setting in the LD5200 with this newly calculated value. This can be edited on the Leak Configuration page of the web interface (Configuration > Leak Settings) or on the Leak Settings screen of the LCD (Setup > Leak Settings).

When using the web interface, remember to click the Submit Changes button to save the adjusted resistance value.

In our example, adjusting the resistance value changed the reported cable length from 391 feet to 380 feet. This improves the accuracy of the system because the reported cable length more closely matches the physical length of cable connected to the system.

2.9 Configure Security Settings

The LD5200 allows users to create a user name for web interface access and set two different passwords for that user.

The Read Only password allows users to access the LD5200's web interface and view the conditions of the system, but does not allow users to make changes to the LD5200's configuration.

The Read/Write password provides users with expanded access. This password allows users to view the conditions of the system and make changes to the LD5200's configuration.

By default, the LD5200's username is: ld5200 (case sensitive)

By default, no password is assigned.

To access the web interface, type ld5200 in the User Name field, leave the password field blank, and press return.

Web interface passwords can only be configured through the web interface. Refer to Chapter 4, "Web" on page 60 for further information.

2.10 General Operation

The LD5200 features both an LCD and a web interface. The LCD is accessible on the front of the device's enclosure, and allows users to quickly access, acknowledge, and configure system settings, alarms, alarm history and device operations. The web interface provides more in-depth access to the LD5200, and allows users to accomplish all the same tasks as the LCD, while addressing some robust, expanded functionality that cannot be utilized through the LCD.

Both interfaces access the same information and data. If you make changes to the LD5200 through the LCD, the changes will show up on the web interface, and vice versa.

Refer to Chapter 3, "LCD Touch Screen Interface" on page 29 for detailed information regarding the LCD. Refer to Chapter 4, "Web Interface" on page 47 for detailed information regarding the web interface.

LCD TOUCH SCREEN INTERFACE

The LD5200's LCD touch screen accommodates basic device configuration and operation. All the functionality you need to operate the LD5200 as a stand-alone device is accessible from the LCD touch screen.

Virtual buttons line the right side of the screen, and they operate much like mechanical buttons. Press the button for the task you want to perform, and the screen for that task is displayed. Avoid using a pen or sharp object to push the buttons - this will damage the LCD.

While button options vary throughout the menus, the most common button structure features four buttons: Up, Down, Select, and Return. They work as follows:



Button	Function
Up	Scroll up through the options. The blue highlight indicates which option you are accessing.
Down	Scroll down through the options. The blue highlight indicates which option you are accessing.
Select	Access the blue highlighted option to edit or confirm settings and data. Press Enter () to submit a value. () is the backspace. Esc returns to the previous menu.
Return	Return to the previous menu.

Table 3.1 LCD - Main Buttons

3.1 Main Menu

When the LD5200 powers up, diagnostics are performed. The boot ROM and flash program code are verified. Once the diagnostics are complete, the LCD displays the Main Menu.

Any time a screen within the LCD interface is left idle for more than five minutes, it will return to this default display.

The Main Menu features basic system information including the device name, current date, time, firmware version running on the system, and current alarm notification.



LCD - Main Menu

Four buttons run down the right side of the LCD and function as follows:

Button	Function	Additional Options Accessible Through Sub-Menus
Silence	Silence the audible alarm	No additional options
Alarms	List current alarms	Display alarm history, acknowledge alarms.
Status	View status information for master and all slave units	View network statistics, EIA-485 data, and the leakage trend log for master and all slave units
Setup	Access and configure a wide variety of system options	Leak settings, virtual zones, slave zones, 4-20mA output, preventative maintenance, system settings, EIA-485 / Modbus / N2 configuration, BACnet configuration, and clear alarm and trend log history

Table 3.2 LCD Main Menu Buttons

3.2 Silence Button

The **Silence** button silences the audible alarm. Press the button once to silence the alarm.

3.3 Alarms Button

The **Alarms** option allows users to display current alarms and alarm history.

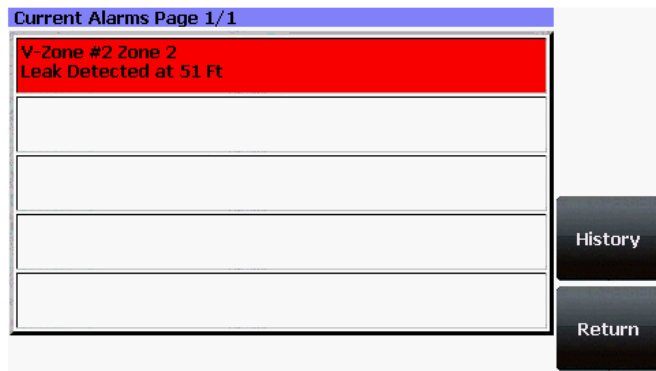

Alarms are color coded as follows:

LCD - Current Alarms

Color	Description
Red	Active alarm - leak detected
Yellow	Active alarm - cable break or contamination detected
Orange	Active alarm - communications problem - one of the monitored slave devices is offline

Table 3.3 LCD Current Alarm Color Codes

Four buttons run down the right side of the LCD and function as follows:

Button	Function	Additional Options Accessible Through Sub-Menus
Next	Advance to the next page of current alarms	No additional options
Previous	Go back to the previous page of current alarms	No additional options
History	View alarm history and acknowledge all unacknowledged alarms	Access the Alarm History screens.
Return	Return to the Current Alarms page.	Return to the Main Menu

Table 3.4 LCD Current Alarm Buttons

3.3.1 History

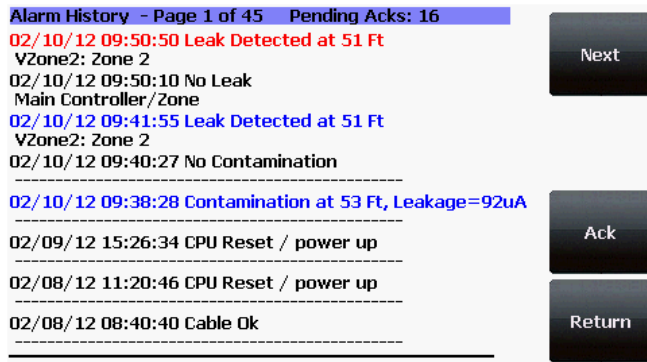

Push this button to display the alarm history. The LD5200 logs the last 1024 alarm events.

LCD - Alarm History

Alarm history data is color coded as follows:

Color	Description
Red	Unacknowledged alarm
Blue	Acknowledged alarm
Black	Alarm condition has returned to normal, or additional information is provided regarding the LD5200's functionality

Table 3.5 LCD Alarm History Color Codes

Use the Next, Previous, and Return buttons to navigate through the alarm history. Four buttons run down the right side of the LCD and function as follows:

Button	Function	Additional Options Accessible Through Sub-Menus
Next	Advance to the next page of alarm history	No additional options
Previous	Go back to the previous page of alarm history	No additional options
Ack	Acknowledge all unacknowledged alarms on the current alarm history page	No additional options
Return	Return to the Current Alarms page.	No additional options

Table 3.6 LCD Alarm History Buttons

3.4 Status Button

The Status button allows you to view current controller status information. Most of these values can be adjusted through the Setup button on the main page of the LCD. The Status page is intended for reference only, not system adjustment.

LD5200 Controller Status	
Alarm Status	Leak Detected at 51 Ft Zone 2
Cable Length	379 Ft
Cable Current	298 μ A
Leg 1 Resistance	1087 Ohms
Leg 2 Resistance	1093 Ohms
Leak Alarm Delay	20 Seconds
Contamination Alarm Delay	0 Seconds
Re-Alarm Countdown	disabled
Last Alarm Time	02/10/12 09:50:50
sysUpTime	0 days 19 hrs 17 mins 48 secs

System
Return

LCD - Controller Status

Attribute	Description
Alarm Status	If the controller is in an alarm state, details regarding the alarm are noted in this field. The field is also color coded to indicate the type of alarm.
Cable Length	The length of sensing cable connected to the controller, as calculated by the LD5200
Cable Current	The amount of current running on the sensing cable
Leg 1 Resistance	The resistance of Leg 1 is displayed in Ohms.
Leg 2 Resistance	The resistance of Leg 2 is displayed in Ohms.
Leak Alarm Delay	The amount of time that passes between the time a leak is detected and the annunciation of the leak alarm.
Contamination Alarm Delay	The amount of time that passes between the time a contamination is detected and the annunciation of that alarm.
Re-alarm Countdown	The amount of time remaining until the active alarm is re-annunciated.
Last Alarm Time	A record of the last time the system detected an alarm condition.
sysUpTime	The amount of time that has passed since the system was last reset or powered on.

Table 3.7 LCD Controller Status Information Fields

This menu features four buttons: Next, Previous, System, and Return:

Button	Function	Additional Options Accessible Through Sub-Menus
Next	If multiple controllers are networked through a master device, push this button to view the next monitored controller.	
Previous	View the previous controller in the list of monitored devices	No additional options
System	View additional system information	Network, EIA-485, Trend, Return
Return	Return to the Current Alarms page.	No additional options

Table 3.8 LCD Controller Status Buttons

3.4.1 System Button

View the system status information for the selected controller. Here you will find a variety of information for the device, including the device's model number, firmware version, MAC and IP addresses, subnet mask, default gateway, and the amount of time the device has been running since it last lost power. A majority of this information is editable through the Setup button on the LCD's main page. This page is intended for reference.

LD5200 System Status	
Model:	LD5200
Flash Application:	LD5200 V2.1.4
MAC Address:	00:90:5B:04:07:DF
IP Address:	10.0.0.75
Net Mask:	255.255.255.0
Default Gateway:	10.0.0.1
SysName:	Operations Floor LD5200
SysUpTime:	0 days 19 hrs 19 mins 47 secs
HTTP Port:	80
Manufacturer:	RLE Technologies 104 Racquette Dr Fort Collins, CO 80524 1-800-518-1519 www.rletech.com

Network

EIA-485

Trend

Return

LCD - System Status

This option features four buttons: Network, EIA-485, Trend, and Return.

Option	Description	Additional Options Accessible Through Sub-Menus
Network	View network statistics for the selected controller.	Reset: Reset the numerical values for all monitored fields in the list to 0. Return: Return to the System page for the selected controller.
EIA-485	View statistics for the three EIA-485 ports.	Reset: Reset the numerical values for all monitored fields in the list to 0. Return: Return to the System page for the selected controller.
Trend	View the leakage trend log. The log catalogs the last 365 entries.	Next: View the next page of logged data. Previous: View the previous page of logged data. Return: Return to the System page for the selected controller.
Return	Return to the Status page.	

Table 3.9 LCD System Status Button Options

3.5 Setup Button

The Setup button provides access to a wide variety of settings, including: leak settings, virtual and slave zone settings, 4-20mA output settings, preventative maintenance options, system setting, EIA-485/modbus/N2 settings, and BACnet options. The clear history buttons are also located within the Setup options.

The Setup options can be password protected. By default, there is no password assigned. The password screen will pop up even if no password is applied to the controller. Press the enter key (↵) to pass through the password screen if no password has been assigned.

Use the buttons on the right side of the LCD to navigate through the menus. The blue highlight indicates which option is selected. Use the buttons on the right side of the LCD to navigate through the menus. Press the Select button to choose the blue highlighted option.

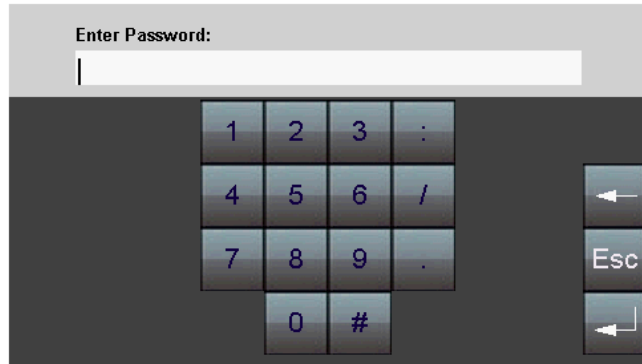

LCD - Password Screen

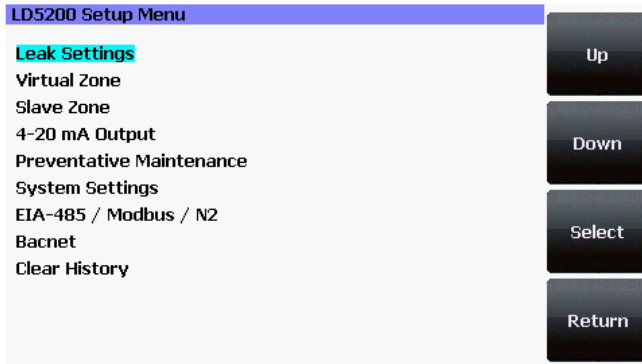

LCD - Setup Menu

3.5.1 Leak Settings

Leak Settings allows you to fine tune the leak detection options available on the LD5200. Use the Up, Down, Select and Return buttons to navigate through the leak settings menu.

LD5200 Leak Settings Menu	
Leak Trip Point:	150 uA (25-175)
Contamination Trip Point:	50 uA (20-175)
Leak Alarm Delay:	20 Seconds (5-990)
Contamination Alarm Delay:	120 Seconds (5-990)
Resistance Per Foot:	2.800 ohms (2.000-4.250)
Re-Alarm Delay:	0 Hours (0-24)
Measurement Display:	Feet
Latching Alarms:	No
Audible Alarm:	Yes
LCD Password:	0000

LCD - Leak Settings

Option	Description
Leak Trip Point	<p>The threshold for the amount of water required to trigger a leak alarm. Adjust this number to adjust the sensitivity of the leak alarm.</p> <p>A lower number yields a more sensitive system, so the system will trigger a leak alarm with less water present.</p> <p>A higher number produces a less sensitive system, so more water is required to trigger an alarm.</p> <p>Enter a value between 25 and 175 microamps.</p> <p>Default setting: 150uA.</p>
Contamination Trip Point	<p>The threshold for the amount of contamination required to trigger a cable contamination alarm. Adjust this number to adjust the sensitivity of the contamination alarm.</p> <p>A lower number yields a more sensitive system, so the system will trigger a contamination alarm with less contamination present.</p> <p>A higher number produces a less sensitive system, so more contamination is required to trigger an alarm.</p> <p>Enter a value between 20 and 175 microamps.</p> <p>Default setting: 50uA.</p>
Leak Alarm Delay	<p>The amount of time that passes between the time a leak is detected and the annunciation of the leak alarm. The leak trip point must be exceeded for the duration of this delay.</p> <p>Enter a value between 5 and 990 seconds.</p> <p>Default setting: 20 seconds</p>

Table 3.10 LCD Leak Settings - Configurable Options

Option	Description
Contamination Alarm Delay	<p>The amount of time that passes between the time a contamination is detected and the annunciation of the contamination alarm. The contamination trip point must be exceeded for the duration of this delay.</p> <p>Enter a value between 5 and 990 seconds.</p> <p>Default setting: 40 seconds</p>
Resistance Per Foot	<p>The resistance per foot of cable determines the LD5200's ability to accurately detect the cable length installed and calculate distances to leaks. Adjust this value to fine-tune the accuracy of a distance-read leak detection system.</p> <p>RLE's sensing cables have a base resistance of 2.800 ohms per foot.</p> <p>Refer to "Calibrate Cable Resistance" on page 25 for detailed resistance calibration.</p> <p>The resistance value must be entered as a 4-digit number between 2.000 and 4.250, with one number in the tens place and three numbers past the decimal point (x.xxx).</p> <p>Default setting: 2.800 ohms per foot.</p>
Re-Alarm Delay	<p>The LD5200 can be set to re-alarm - after a leak or contamination has been detected, the alarm will be re-sent at a defined interval until the alarm condition has been resolved. The re-alarm triggers both the audible alarm and the direct notification alarm.</p> <p>The interval is adjustable in whole hour increments. Decimal values are not allowed. Enter a number from 0 to 24. A 0 in this field turns off the re-alarm option, so only one alarm notification will be sent for each alarm.</p> <p>Default setting: 0 (disabled)</p>
Measurement Display	<p>Select either feet or meters to calibrate the LD5200 to the preferred unit of measure. All distance calculations will adjust accordingly.</p> <p>Default setting: Feet</p>

Table 3.10 LCD Leak Settings - Configurable Options

Option	Description
Latching Alarms	<p>A non-latching alarm resets itself once a detected leak or contamination has been resolved.</p> <p>A latching alarm must be manually acknowledged before its annunciation clears, even if the detected leak or cable problem is no longer present.</p> <p>Select Yes (latching) or No (non-latching).</p> <p>Default setting: No (non-latching alarms)</p>
Audible Alarm	<p>Select Yes to activate the audible alarm annunciation. Select No to deactivate the audible alarm annunciation.</p> <p>Default setting: No (audible alarm disabled)</p>
LCD Password	<p>Establish a 4-digit numerical password to restrict access to the Setup series of menus. Set the value to 0000 to disable password protection.</p> <p>Default setting: 0000 (no password)</p>

Table 3.10 LCD Leak Settings - Configurable Options

3.5.2 Virtual Zone

A virtual zone is a labeled reference point in a leak detection system. A virtual zone can consist of a room, a drip pan containing a spot detector under an air handler unit, a combination of rooms and components, or any other defined area whose identification would help in the location of leaks.

The LD5200 allows you to establish up to 32 virtual leak detection zones. Dividing a leak detection system into zones helps locate leaks quickly. It simplifies troubleshooting by allowing you to isolate different sections of cable as separately defined areas. Use the Virtual Zone Settings page to configure the LD5200's virtual zones

Use the Up, Down, Select and Return buttons to navigate through the virtual zone menus.

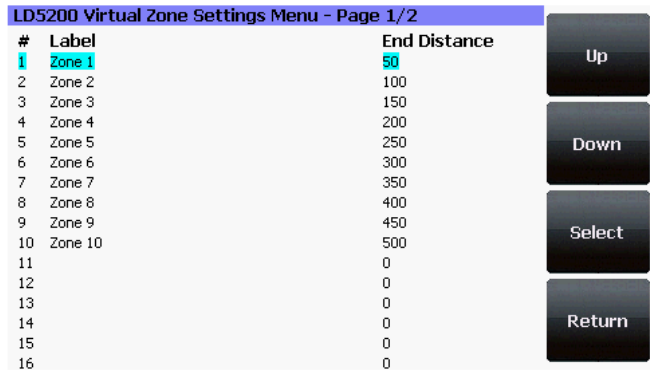

LCD - Virtual Zone Settings Menu

Push the Select button to choose the blue highlighted zone you wish to configure or edit. Use the LCD keyboard to give the zone a descriptive identifier. Push the Return button and log the end distance for that particular virtual zone. To delete a virtual zone, select the zone and delete the text from all fields.

Option	Description
#	A fixed number, 1 - 32, used to designate the Zone.
Label	A descriptive label for the zone, 30 characters or less.
End Distance	Record the sensing cable's distance measurement at the END of the zone. Zone 1 starts at 0 feet / meters, and you designate the end point for Zone 1. Zone 2 starts at zone 1's ending distance; you designate where Zone 2 ends. Each subsequent zone begins where the previous zone ends.

Table 3.11 LCD Virtual Zone Settings - Configurable Options

3.5.3 Slave Zone

Slave zones are secondary physical controllers that report to the LD5200. Zone controllers and distance-read controllers can be networked as slaves to a master LD5200. Up to 128 slave devices can report to one LD5200.

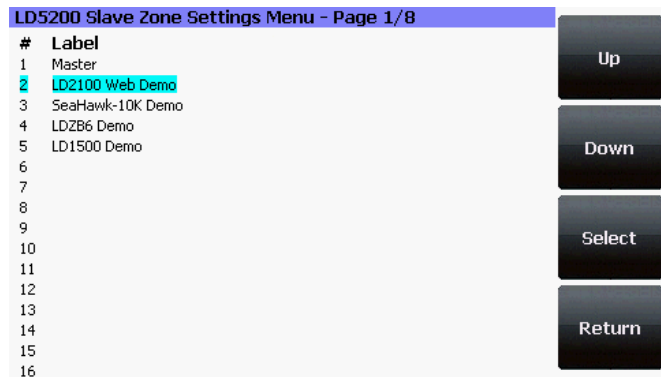

LCD - Slave Zone Settings Menu

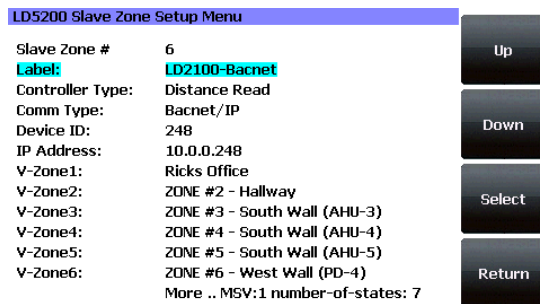

LCD - Slave Zone Setup Menu - Bacnet

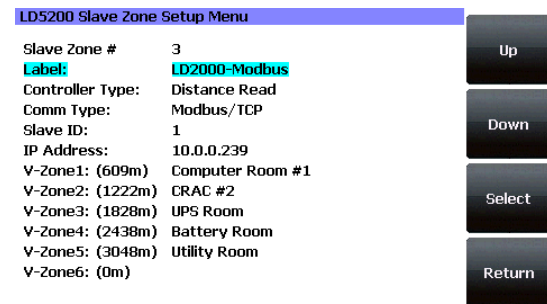

LCD - Slave Zone Setup Menu- Modbus

Option	Description
Slave Zone #	Non-editable; defined by the blue highlighted device you chose to configure.
Label	Enter a name for the slave controller, 30 characters or less.
Controller Type	Designate the slave device as zone or distance read
Comm Type	Select a communications type for the slave device: Comms Disabled EIA-485 port 1 EIA-485 Port 2 EIA-485 Port 3 Modbus/TCP Modbus/UDP Bacnet/IP
Slave ID	Designate the Slave ID or Device ID
IP Address	Enter the IP Address of the slave device.
V-Zone	Label the virtual zones. A device communicating via Modbus will have editable zone names and end distances. A device communicating via Bacnet will be read-only - the LD5200 will obtain the information from the other controller.

Table 3.12 LCD Slave Zones Setup - Configurable Options

3.5.4 4-20mA Output

The 4-20mA output only reports up to 5,000 feet of sensing cable.

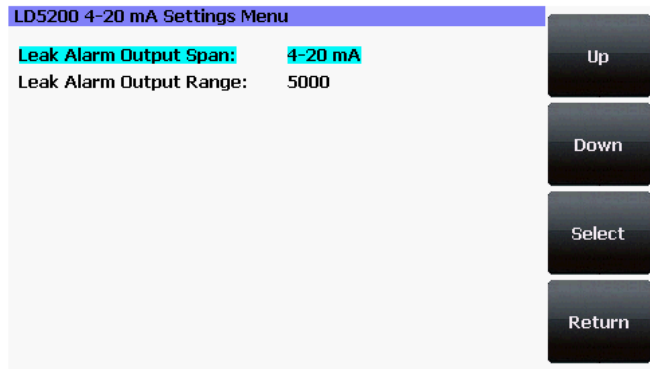

LCD - 4-20mA Output Settings Menu

Option	Description
Leak Alarm Output Span	Selectable: 5-19 mA (default) 4-20 mA
Leak Alarm Output Range	Selectable: 1000 (default) 2500 5000

Table 3.13 LCD 4-20mA Settings - Configurable Options

3.5.5 Preventative Maintenance

Preventative maintenance keeps a leak detection system running efficiently and reliably. Use this option to program a preventative maintenance alarm reminder into the system.

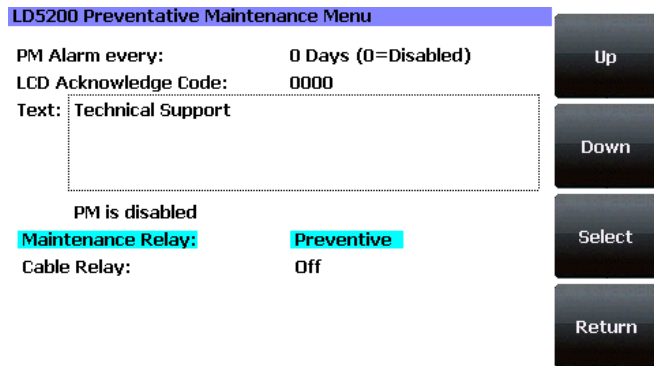

LCD - Preventative Maintenance Menu

Option	Description
PM Alarm every:	Select a span of days to elapse between maintenance alarms, from 30-720 days. Set the value to 0 to disable this option. Default setting: 0 (disabled)
LCD Acknowledge Code	Establish a 4-digit numerical code to acknowledge the preventative maintenance alarm. Set the value to 0000 if you don't wish to have a password. Default setting: 0000 (no password)
Text	Designate text to display when the maintenance reminder is triggered. Enter up to four lines of text (30 characters per line)
Maintenance Relay	The relay output can be configured either as a preventative maintenance reminder or a power fail notification to alert you when power to the unit is lost. Default setting: Preventative Maintenance
Cable Relay	Used to troubleshoot the controller, this feature simulates 8060 ohms of leak detection cable (approximately 2878 feet of 2.8 ohms/foot cable) for up to 5 minutes. Turn this feature on and the look at the Status screen of the LCD. If the controller is functioning properly, the cable length will register approximately 2878 feet, and the leg 1 and leg 2 resistance will be approximately 8060 ohms.

Table 3.14 LCD Preventative Maintenance - Configurable Options

3.5.6 System Settings

A variety of settings are available to make your LD5200 easy to identify. Use this option to edit the system information.

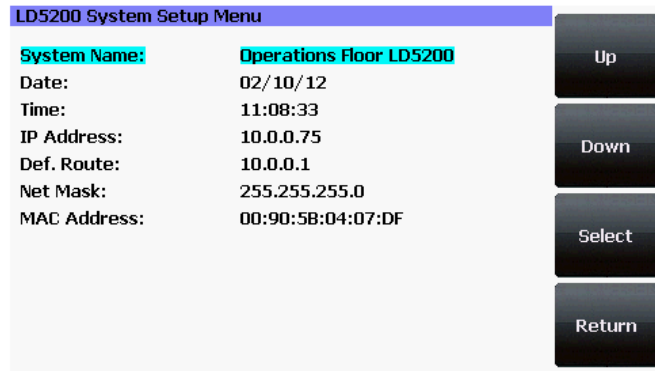

LCD - System Setup Menu

Option	Description
System Name	Designate a unique name for the LD5200, up to 30 characters.
Date	Adjust the current date, in mm/dd/yy format, if necessary.
Time	Adjust the current time, in hh:mm:ss format, if necessary.
IP Address	Set the IP address for the LD5200, so it can communicate on your network. If you do not have an IP address for the device, obtain one from your IT department. Default IP address: 10.0.0.188
Def. Route	Designate the device's default route (default gateway). If you do not have a default route, obtain one from your IT department. Default device route: 10.0.0.1
Net Mask	Designate the device's Subnet Mask. Contact your IT department for further information. Default subnet mask: 255.255.255.0
MAC Address	The MAC address is a unique identifier set by the manufacturer, and is non-editable.

Table 3.15 LCD System Settings - Configurable Options

3.5.7 EIA-485 / Modbus / N2

If the LD5200 will be communicating via the EIA-485 port, configure the necessary options here.

LD5200 EIA485/Modbus/N2 Setup Menu	
TCP/UDP UID:	0
Alarm Relay:	Disabled
EIA-485 Port1:	Modbus Slave
Port1 Baud Rate:	38400
Port1 Slave Address:	1
EIA-485 Port2:	Bacnet Ms/Tp-Slave
Port2 Baud Rate:	38400
Port2 Slave Address:	2
EIA-485 Port3:	Modbus Slave
Port3 Baud Rate:	9600
Port3 Slave Address:	1

Up

Down

Select

Return

Menu selections are as follows:

LCD - EIA485/Modbus/N2 Setup Menu

Option	Description
TCP/UDP UID	Set the TCP/UDP unique identifier. this will be a value between 1 and 254. A value of 0 disables this option.
Alarm Relay	Enable or disable the alarm relay.
EIA-485 Port 1	Select Modbus-Slave or Modbus-Master
Port 1 Baud Rate	Selectable: 9600, 19200, or 38400
Port 1 Slave Address	Set the slave address, 1-254. 0 = disabled.
EIA-485 Port 2	Select Modbus-Slave, Bacnet Ms/Tp Slave, Modbus-Master, or N2 (fixed, 9600, n,1)
Port 2 Baud Rate	Selectable: 9600, 19200, or 38400
Port 2 Slave Address	Set the slave address, 1-254. 0 = disabled.
EIA-485 Port 3	Select Modbus-Slave or Modbus-Master
Port 3 Baud Rate	Selectable: 9600, 19200, or 38400
Port 3 Slave Address	Set the slave address, 1-254. 0 = disabled.

Table 3.16 LCD EIA-485 / Modbus / N2 Setup - Configurable Options

3.5.8 Bacnet

The LD5200 can communicate via BACnet. BACnet allows building automation and control devices to communicate, regardless of the building services they perform.

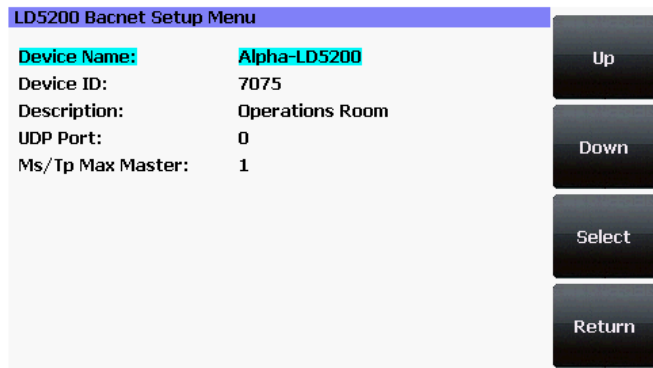

Use this screen to configure BACnet options.

LCD - Bacnet Setup Menu

Option	Description
Device Name	Designate a unique name for the LD5200, up to 30 characters.
Device ID	Set the device ID, up to 30 characters. 0 = disabled.
Description	Enter a description for the device, up to 30 characters.
UDP Port	Enter a 0 to specify port 47808 (0xBAC0) as the UDP port. If another port value is specified by your application, enter that value here. Default setting: 0
Ms/Tp Max Master	Represents the number of devices on the EIA-485 string. Commonly, the Max Master is set to the same setting as the BACnet master.

Table 3.17 LCD Bacnet Setup - Configurable Options

3.5.9 Clear History

Select this option to clear the Alarm History and Trend Logs.

CHAPTER

4

WEB INTERFACE

The LD5200’s LCD accommodates most device control and configuration. For more in-depth functionality, use the web interface.

To access your LD5200’s web interface, type the device’s IP address into your web browser’s location bar.

4.1 Home Page

The LD5200’s home page features basic system information, including current alarm status, the reported length of sensing cable connected to the system, the last time the system went into alarm, and the running system uptime. The image to the right of the table can be customized, and can be linked to interactive floor maps.

The row of links inside the blue bar at the top of the page act like tabs, and provide access to a variety of expanded functionality and configuration options.

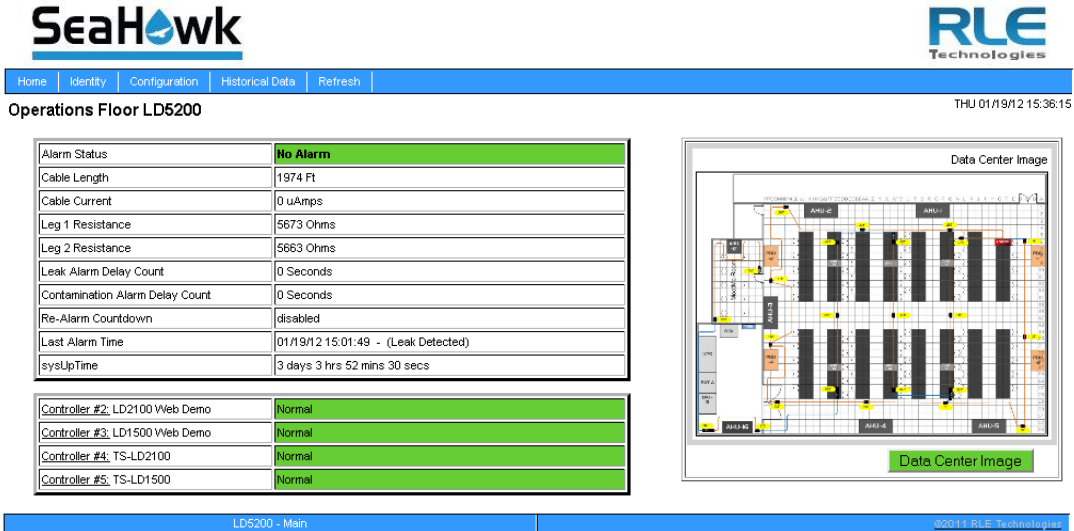

Figure 4.1 LD5200 Web Interface Home Page

The home page also provides annunciation for active alarms.

SeaHawk **RLE Technologies**

Home Identity Configuration Historical Data Refresh

Operations Floor LD5200 FRI 02/10/12 09:44:34

Alarm Status	Leak Detected at 51 Ft - Zone 2
Cable Length	379 Ft
Cable Current	298 uAmps
Leg 1 Resistance	1086 Ohms
Leg 2 Resistance	1092 Ohms
Leak Alarm Delay Count	20 Seconds
Contamination Alarm Delay Count	0 Seconds
Re-Alarm Countdown	disabled
Last Alarm Time	02/10/12 09:41:55 - (Leak Detected)
sysUpTime	0 days 18 hrs 16 mins 9 secs

Data Center Image

Data Center Image

LD5200 - Main ©2011 RLE Technologies

Figure 4.2 LD5200 Web Interface Home Page with Active Leak Detected Alarm

4.2 Identity

The Identity link displays basic LD5200 information, including model number, system name, contact information, firmware version, and IP address. Most of these values can be adjusted through the Configuration screens. This page is intended for reference only, not system adjustment.

SeaHawk **RLE Technologies**

Home Identity Configuration Historical Data Refresh

Operations Floor LD5200 TUE 06/25/13 10:39:06

Model	LD5200
Flash Application	LD5200 V2.1.20
Flash Appl. Size	773392
Bootloader Version	LD5200 BOOT V2.0.1
MAC Address	00:90:5B:F0:52:44
IP Address	10.0.0.237
Net Mask	255.255.255.0
Def Route	10.0.0.1
sysUpTime	3 days 14 hrs 15 mins 0 secs
System Name	Operations Floor LD5200
System Contact	Technical Support support@rletech.com
System Location	RLE Technologies, 104 Racquette Drive, Fort Collins, CO 80524

LD5200 - Main ©2011 RLE Technologies

Figure 4.3 Identity Page

4.3 Configuration

The Configuration link provides access to a series of sub-menus from which users can adjust system settings.

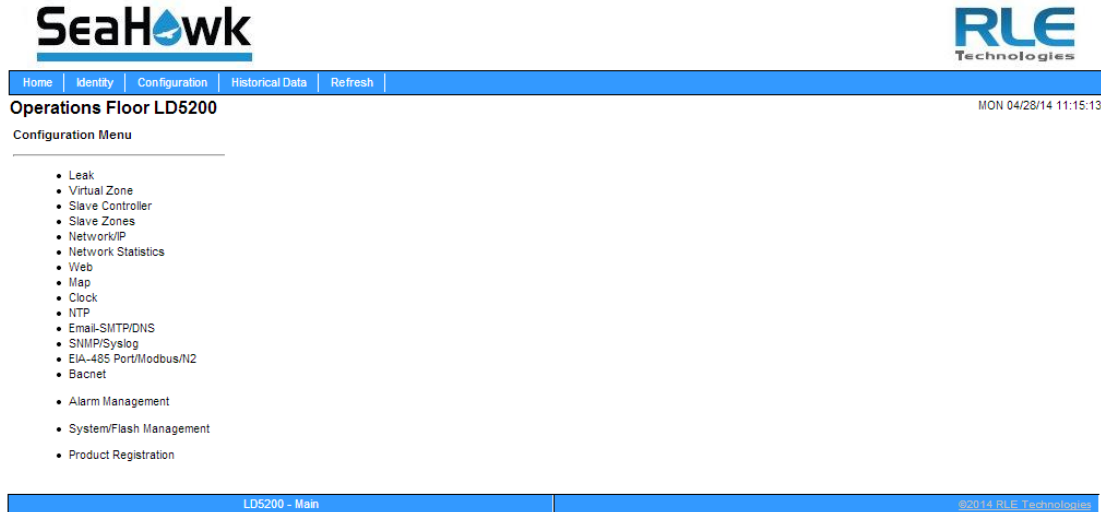

Figure 4.4 Configuration Page

NOTE If any of the fields within the sub-menus are edited, be sure to click the **Submit Changes** button to save the changes. If you edit the fields and navigate from the web page without clicking the **Submit Changes** button, all changes will be lost.

4.3.1 Leak

Use the Leak Configuration page to fine tune system variables, including leak and contamination thresholds, latching and unlatching alarms, and sensing cable resistance.

Leak Configuration

Leak Trip Point: uA (25-175)

Contamination Trip Point: uA (20-175)

Leak Alarm Delay: Seconds (5-990)

Contamination Alarm Delay: Seconds (5-990)

Resistance Per Foot: x.xxx ohms (2.000-4.250)

Re-Alarm Interval: (0-24 Hours)

Measurement Display: Feet Meters

Latching Alarms: No Yes

Audible Alarm: Enabled Disabled

LCD Password: (numeric - 4 digits)

Length Calibration Factor: 0.999009 8076/8068

4-20 mA Leak Alarm Output Span:

4-20 mA Leak Alarm Output Range:

Preventative Maintenance Alarm: Days (0=Disabled, Range: 30-720)

Preventative Maintenance LCD Ack Code: PM is disabled

Preventative Maintenance Text:
(sysContact)

Maintenance Relay: Preventive Power Fail

LCD Midnight Reset: Enabled Disabled

- This will simulate 8060 ohms of cable for an approx. length reading of 2846 ft - for up to 5 minutes

Figure 4.5 Leak Configuration Page

Option	Description
Leak Trip Point	<p>The threshold for the amount of water required to trigger a leak alarm. Adjust this number to adjust the sensitivity of the leak alarm.</p> <p>A lower number yields a more sensitive system, so the system will trigger a leak alarm with less water present.</p> <p>A higher number produces a less sensitive system, so more water is required to trigger an alarm.</p> <p>Enter a value between 25 and 175 microamps.</p> <p>Default setting: 150uA.</p>
Contamination Trip Point	<p>The threshold for the amount of contamination required to trigger a cable contamination alarm. Adjust this number to adjust the sensitivity of the contamination alarm.</p> <p>A lower number yields a more sensitive system, so the system will trigger a contamination alarm with less contamination present.</p> <p>A higher number produces a less sensitive system, so more contamination is required to trigger an alarm.</p> <p>Enter a value between 20 and 175 microamps.</p> <p>Default setting: 50uA.</p>
Leak Alarm Delay	<p>The amount of time that passes between the time a leak is detected and the annunciation of the leak alarm.</p> <p>The leak trip point must be exceeded for the duration of this delay.</p> <p>Default setting: 20 seconds</p>
Contamination Alarm Delay	<p>The amount of time that passes between the time a contamination is detected and the annunciation of the contamination alarm.</p> <p>The contamination trip point must be exceeded for the duration of this delay.</p> <p>Default setting: 40 seconds</p>

Table 4.1 Leak Configuration Options

Option	Description
Resistance Per Foot	<p>The resistance per foot (or meter) of cable determines the LD5200's ability to accurately detect the cable length installed and calculate distances to leaks. Adjust this value to fine-tune the accuracy of a distance-read leak detection system.</p> <p>RLE's sensing cables have a base resistance of 2.800 ohms per foot.</p> <p>Refer to "Calibrate Cable Resistance" on page 25 for detailed resistance calibration.</p> <p>The resistance value must be entered as a 4-digit number between 2.000 and 4.250, with one number in the tens place and three numbers past the decimal point (x.xxx).</p> <p>Default setting: 2.800 ohms per foot.</p>
Re-Alarm Interval	<p>The LD5200 can be set to re-alarm - after a leak or contamination has been detected, the alarm will be re-sent at a defined interval until the alarm condition has been resolved. The re-alarm triggers both the audible alarm and the direct notification alarm.</p> <p>Enter a number from 0 to 24. A 0 in this field turns off the re-alarm option, so only one alarm notification will be sent for each alarm.</p> <p>Default setting: 0 (disabled)</p>
Measurement Display	<p>Select either feet or meters to calibrate the LD5200 to the preferred unit of measure. All distance calculations will adjust accordingly.</p> <p>Default setting: Feet</p>
Latching Alarms	<p>A non-latching alarm resets itself once a detected leak or contamination has been resolved.</p> <p>A latching alarm must be manually acknowledged before its annunciation clears, even if the detected leak or cable problem is no longer present.</p> <p>Select Yes (latching) or No (non-latching).</p> <p>Default setting: No (non-latching alarms)</p>
Audible Alarm	<p>Select Enabled to activate the audible alarm annunciation. Disable this option to deactivate the audible alarm annunciation.</p> <p>Default setting: Disabled</p>

Table 4.1 Leak Configuration Options (continued)

Option	Description
LCD Password	<p>Establish a 4-digit numerical code to access the Setup series of menus through the LCD. Set the value to 0000 if you don't wish to have a password.</p> <p>Default setting: 0000 (no password)</p>
Length Calibration Factor	Reserved for manufacturer's use only.
4-20mA Leak Alarm Output Span	<p>Selectable: 5-19mA or 4-20mA</p> <p>Default setting: 5-19mA</p>
4-20mA Leak Alarm Output Range	<p>Selectable:</p> <ul style="list-style-type: none"> 1000 feet 2500 feet 5000 feet 7500 feet 10000 feet <p>Default setting: 1000 feet</p>
Preventative Maintenance Alarm	<p>Preventative maintenance keeps a leak detection system running efficiently and reliably. Use this option to program a preventative maintenance alarm reminder into the system.</p> <p>Select a span of days to elapse between maintenance alarms, from 30-720 days. Set the value to 0 to disable this option.</p> <p>Default setting: 0 (disabled)</p>
Preventative Maintenance LCD Ack Code	<p>Establish a 4-digit numerical code to acknowledge the preventative maintenance alarm. Set the value to 0000 if you don't wish to have a password.</p> <p>Default setting: 0000 (no password)</p>
Preventative Maintenance Text	<p>Designate text to display when the maintenance reminder is triggered.</p> <p>Enter up to four lines of text (30 characters per line)</p> <p>Default setting: blank</p>

Table 4.1 Leak Configuration Options (continued)

Option	Description
Maintenance Relay	<p>The relay output can be configured either as a preventative maintenance reminder or a power fail notification to inform you when power to the unit is lost.</p> <p>Default setting: Preventative Maintenance</p>
LCD Midnight Reset	<p>By default the unit's LCD will reset at midnight every night. In some rare instances, this causes the device to have a momentary connectivity failure at midnight. If a loss of connectivity is being reported at your facility, you can disable the LCD reset.</p> <p>Use this option to enable or disable the 12:00 a.m. LCD reset.</p> <p>Default: Enabled</p>

Table 4.1 Leak Configuration Options (continued)

Set Cable Relay Button - Used to troubleshoot the controller, this button simulates 8060 ohms of leak detection cable (approximately 2878 feet of 2.8 ohms/foot cable) for up to 5 minutes. Push the button and then look at the web interface home page. If the controller is functioning properly, the cable length will register approximately 2878 feet, and the leg 1 and leg 2 resistance will be approximately 8060 ohms.

4.3.2 Virtual Zone

A virtual zone is a labeled reference point in a leak detection system. A virtual zone can consist of a room, a drip pan containing a spot detector under an air handler unit, a combination of rooms and components, or any other defined area whose identification would help in the location of leaks.

The LD5200 supports up to 32 virtual zones. Dividing a leak detection system into zones helps locate leaks quickly. It simplifies troubleshooting by allowing you to isolate different sections of cable as separately defined areas.

Virtual Zone Configuration					
Submit Changes				Feet	
Zone #	Label	End Distance	Zone #	Label	End Distance
1	Zone 1	50	17		0
2	Zone 2	100	18		0
3	Zone 3	150	19		0
4	Zone 4	200	20		0
5	Zone 5	250	21		0
6	Zone 6	300	22		0
7	Zone 7	350	23		0
8	Zone 8	400	24		0
9	Zone 9	450	25		0
10	Zone 10	500	26		0
11	Zone 11	600	27		0
12	Zone 12	700	28		0
13		0	29		0
14		0	30		0
15		0	31		0
16		0	32		0

Figure 4.6 Virtual Zone Configuration Page

Option	Description
Zone #	A fixed number, 1 - 32, used to designate the Zone.
Label	Type a descriptive label for the zone, 30 characters or less.
End Distance	Record the sensing cable's distance measurement at the END of the zone. Zone 1 starts at 0 feet / meters, and then you designate the end point for Zone 1. Zone 2 starts at zone 1's ending distance; you designate where Zone 2 ends. Each subsequent zone begins where the previous zone ends.

Table 4.2 Virtual Zone Configuration Options

4.3.3 Slave Controller

The LD5200 can act as a Modbus or Bacnet IP master for other RLE leak detection devices. Up to 127 slave devices can be connected to one LD5200. To configure the LD5200 as a Modbus master, refer to Chapter 5, “Modbus Communication” on page 87.

Page 1 of 8 Jump to page: -- ▾

Modbus/Slave Controller/Zone Configuration					
<input type="button" value="Submit Changes"/>					
Controller	Label	Control Type	Enable Comm Type	Address / Slave ID / Device ID	IP Address
1			Master	(-)	
2	LD2100 Web Demo	Distance Read ▾	Modbus/TCP ▾	1	23.24.146.56
3	LD1500 Demo	Distance Read ▾	Modbus/UDP ▾	21	23.24.146.53
4	LD2100 Web Demo - Bacnet	Distance Read ▾	Bacnet/IP ▾	7254	23.24.146.56
5		Distance Read ▾	Disabled ▾	0	0.0.0.0
6		Distance Read ▾	Disabled ▾	0	0.0.0.0
7		Distance Read ▾	Disabled ▾	0	0.0.0.0
8		Distance Read ▾	Disabled ▾	0	0.0.0.0
9		Distance Read ▾	Disabled ▾	0	0.0.0.0
10		Distance Read ▾	Disabled ▾	0	0.0.0.0
11		Distance Read ▾	Disabled ▾	0	0.0.0.0
12		Distance Read ▾	Disabled ▾	0	0.0.0.0
13		Distance Read ▾	Disabled ▾	0	0.0.0.0
14		Distance Read ▾	Disabled ▾	0	0.0.0.0
15		Distance Read ▾	Disabled ▾	0	0.0.0.0
16		Distance Read ▾	Disabled ▾	0	0.0.0.0

Figure 4.7 Slave Controller Configuration Page.

Option	Description
Jump to Page	Use this drop down menu to access additional devices.
Controller #	A fixed number, 1 - 127, used to designate the controller.
Label	Type a descriptive label for the controller, 30 characters or less.
Control Type	Designate the slave device as distance read or zone
Enable Comm Type	Select a communications type for the slave device: Disabled EIA-485 Port1 EIA-485 Port2 EIA-485 Port3 Modbus/TCP Modbus/UDP Bacnet/IP
Address/Slave ID/ Device ID	Designate the Slave ID or Device ID.
IP Address	Enter the IP Address of the slave device

Table 4.3 Slave Controller Configuration Options

4.3.4 Slave Zones

If you have designated controllers on the Slave Configuration page, then use this page to label the slave zone(s). Your available labeling and configuration options will change depending on the type of device, and how you're obtaining the information. If you are pulling in data via BACnet IP, the fields will display but will be read only. If there are no slave devices configured on the unit, you will be rerouted back to the main Configuration page.

Slave Controller #2 Jump to controller: -- ▾

Slave Controller #2 Zone Configuration

LD2100 Web Demo

Virtual Zone #	Label	End Distance
1	East wall	75
2	South Wall	125
3	West Wall	300
4	North Wall	400
5		0
6		0

Figure 4.8 Slave Zone Configuration Page, Distance-Read via Modbus

Slave Controller #5 Jump to controller: -- ▾

Slave Controller #5 Zone Configuration

F200

LDZ Zone #	Label
1	Boiler Room
2	Janitor Closet
3	Battery Room
4	
5	
6	

Figure 4.9 Slave Zone Configuration Page, Zone

Option	Description
Jump to Unit	Use this drop down menu to access additional devices.
Zone #	A fixed number used to designate the controller, as configured on the Slave Configuration menu.
Label	Type a descriptive label for the controller, 30 characters or less.
End Distance	For distance-read systems, the distance reading at the end of that virtual zone.

Table 4.4 LDZ/Slave Zone Label Configuration Options

4.3.5 Network/IP

The Network/IP page displays the assigned MAC address and allows users to configure common network information. Editing this information will change the way the web interface operates. Only change this information if you have been in contact with your network administrator, and are sure the changes are correct.

IP Configuration

Warning: Changing these parameters will cause the network interface to operate differently, only change parameters if you are sure the changes are correct.

MAC Address: 00:90:5B:04:07:E0

IP Address:

Net Mask:

Def Route:

Http Port: (Default 0 = 80)

Tcp Max Seg Size: 1436 536

Disable Network Watchdog: No Yes

Figure 4.10 Network/IP Configuration Page

Option	Description
MAC Address	The MAC address is a unique identifier set by the manufacturer, and is non-editable.
IP Address	Set the IP address for the LD5200, so it can communicate on your network. If you do not have an IP address for the device, obtain one from your IT department. Default IP address: 10.0.0.188
Net Mask	Designate the device's Subnet Mask. Contact your IT department for further information. Default subnet mask: 255.255.255.0
Def Route	Designate the device's default route (default gateway). If you do not have a default route, obtain one from your IT department. Default device route: 10.0.0.1
Http Port	Some ISPs use alternate http ports as an added security measure. Edit this field in accordance with your ISPs security settings. Default: 0 = Port 80
Tcp Max Seg Size	The LD5200 defaults to 1436 packet size for web page data. Users may select 536 for limited bandwidth or VPN applications. Default: 1436
Disable Network Watchdog	The network watchdog is used to reboot the device if excessive network traffic or errors are detected. Default: No

Table 4.5 Network/IP Configuration Options

4.3.6 Network Statistics

The Network Statistics link displays a snapshot of the most recent network information.

```

Netstats for Mac: 00:90:5B:04:07:E0 IP: 10.0.0.85

ints:      1015283      inpackets: 1015655      processed: 1015656
refused:   0           arp:         393340       ip:         603013
tx sent:   778688      tx refused:  0           tcp retries: 1
tcp_timeouts:0

RMON_T_DROP           = 0           RMON_T_PACKETS      = 778688
RMON_T_BC_PKT        = 1927        RMON_T_MC_PKT       = 0
RMON_T_CRC_ALIGN     = 0           RMON_T_UNDERSIZE    = 0
RMON_T_FRAG          = 0           RMON_T_JAB         = 0
RMON_T_COL           = 0           RMON_T_P64         = 439529
RMON_T_P65TO127     = 177884     RMON_T_P128TO255   = 15
RMON_T_P256TO511    = 23          RMON_T_P512TO1023  = 3630
RMON_T_P1024TO2047  = 157607     RMON_T_P_GTE2048   = 0
RMON_T_OCTETS        = 276749509  IEEE_T_DROP         = 0
IEEE_T_FRAME_OK      = 140         IEEE_T_ICOL         = 0
IEEE_T_MCOL          = 0           IEEE_T_DEF          = 263
IEEE_T_LCOL          = 0           IEEE_T_EXCOL        = 0
IEEE_T_MACERR        = 0           IEEE_T_MACERR       = 0
IEEE_T_CSERR         = 778423     IEEE_T_SQE          = 0
IEEE_T_FDXFC         = 0           IEEE_T_OCTETS_OK    = 276749509
RMON_R_PACKETS       = 1263976    RMON_R_BC_PKT       = 533381
RMON_R_CRC_ALIGN     = 0           RMON_R_UNDERSIZE    = 0
RMON_R_OVERSIZE      = 0           RMON_R_FRAG         = 0
RMON_R_JAB           = 0           RMON_R_RESVD_0      = 0
RMON_R_P64           = 714708     RMON_R_P64          = 714708
RMON_R_P65TO127     = 352279     RMON_R_P128TO255   = 35270
RMON_R_P256TO511    = 161080     RMON_R_512TO1023   = 504
RMON_R_P_GTE2048    = 0           RMON_R_1024TO2047  = 135
RMON_R_OCTETS        = 138467656  IEEE_R_DROP         = 0
IEEE_R_FRAME_OK      = 1015663    IEEE_R_CRC          = 0
IEEE_R_ALIGN         = 0           IEEE_R_MACERR       = 1
IEEE_R_FDXFC         = 0           IEEE_R_OCTETS_OK    = 78634896

```

[Refresh netstats page](#)

[Reset netstats](#)

[Return to configuration](#)

Figure 4.11 Network Statistics Page

4.3.7 Web

Use this page to establish passwords and a username for the web interface, and to customize the web interface's home page with your own graphics and links.

The screenshot shows a web configuration interface with a blue header bar labeled "Web Configuration". Below the header is a "Submit Changes" button. The configuration fields are as follows:

- Web Username:** A text input field with a note "(If blank, default username is ld5200)".
- Web Password Read Only:** A text input field.
- Web Password Read/Write:** A text input field.
- Web Refresh Rate:** A numeric input field containing "10" followed by the text "Seconds".
- Main Page Image:** A dropdown menu currently showing "Floor Map 1".

Figure 4.12 Web Configuration Page

Option	Description
Web Username	Designate a username used to access the web interface. Default username: ld5200
Web Password Read Only	Two separate passwords can be configured on the LD5200. The Read Only password allows users to access the LD5200's web interface and view the conditions of the system, but does not allow users to make changes to the LD5200's configuration. Default password: field is left blank (no password required)
Web Password Read/Write	The second configurable password on the LD5200 provides users with expanded access. The Read/Write password allows users to view the conditions of the system and make changes to the LD5200's configuration. Default password: field is left blank (no password required)
Web Refresh Rate	Decide how often the web page refreshes - checks for new data and reloads the web page - when left in an open web browser. Enter a value from 10 to 999 seconds. If you enter 0, the screen will not refresh on its own - you'll have to click the refresh button on your web browser or press F5 to refresh the screen. Default setting: 10 seconds
Main Page Image	One image appears in the double-lined box on the right side of the home page. Images are uploaded through the Map page of the web interface. Select an image from the drop down list of uploaded images. Default setting: Seahawk

Table 4.6 Web Configuration Options

4.3.8 Map

The LD5200 allows users to upload up to 10 maps of their facilities and populate them with leak detection data. This provides users with a real-time view of their facility, including the physical location and status of their leak detection equipment, and a visual indication of any active alarms.

Through the mapping process, the LD5200 creates an overlay for an uploaded map image. It superimposes the locations of your equipment - based on coordinates you designate - over the top of your map image. Once uploaded and populated, the map is accessible through the buttons generated on the right side of the LD5200 home page.

Do not attempt to map your facility until your monitoring area is completely assembled - all of your leak detection equipment is in place, tested, and functional.

You'll need a map of your facility. You can draw maps yourself, or RLE can create maps from sketches or mechanical drawings that you provide. When creating your own map and image file, keep in mind that the image file must be:

- ◆ 500kb or less in size
- ◆ 4000 x 4000 pixels or less
- ◆ A .jpg, .jpeg, .bmp, .gif, or .png formatted file.

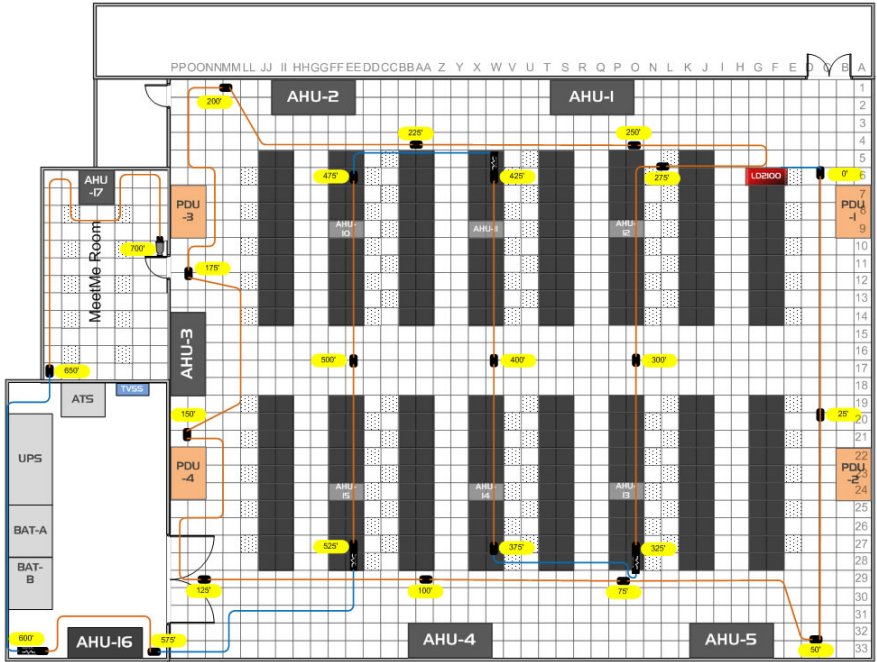

Figure 4.13 Leak Detection Reference Map

A .pdf or .vsd image can be uploaded to the LD5200, but .pdf and .vsd files do not support the interactive mapping overlays. Upload .pdf and .vsd files for visual reference only.

Since the LD5200 never actually edits your map, if you should need to update your map image, previously designated map points will not need to be reconfigured. As long as you do not change size of your map, previously mapped coordinates should not need to be adjusted when you upload a new version of your map.

The LD5200 allows users to upload 10 maps, and make all 10 of the maps interactive. Use the drop down menu on the upper right side of the Map Configuration screen (shown below) to upload and configure each individual map.

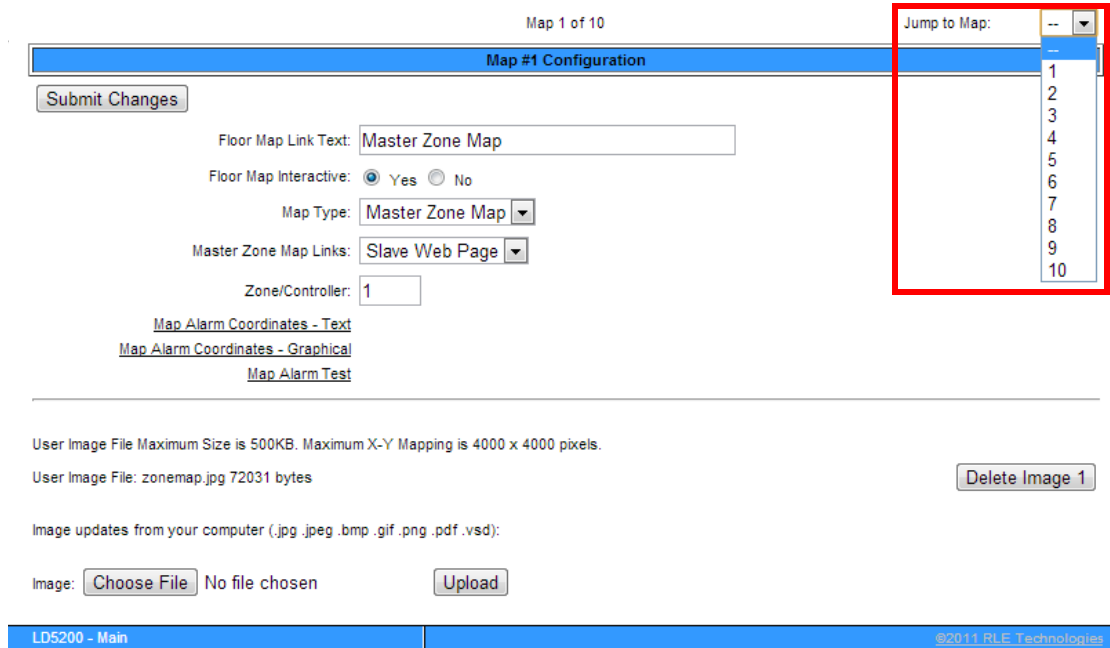

Figure 4.14 Map Settings Page

Option	Description
Jump to Map	The LD5200 lets users upload and populate up to 10 different maps. Use this drop down menu to select the appropriate reference number for the map.
Floor Map Link Text	Each map has its own link from the LD5200’s home page. A button will be created on the right side of the home page. Click this button to launch a new browser window that displays a full-sized version of the map and mapped points. Designate the text that appears on the button that links to this specific floor map.
Floor Map Interactive	Select Yes to create an interactive overlay for your image - designate mapped location that will show the status of your system. Select No if you’d like the image to display as a plain image through the LD5200, without interactive mapping capabilities. Default setting: No

Table 4.7 Map Settings Options

Option	Description
Map Type <i>Only available on Map 1</i>	<p>Distance Read - the traditional map overlay, use this option to plot points and pinpoint a leak's location with sensing cable.</p> <p>Master Zone Map - only available for map #1, this option allows users to view the status of all of their configured physical zones from one map.</p> <p>If one of the zones reports an alarm condition, that condition will appear as an appropriately colored box on the map. Zone 1 will always represent the LD5200 you're working with.</p> <p>In this example, three zones are being monitored and no alarms are present.</p>  <p>Default setting: Distance Read</p>
Master Zone Map Links	<p>The zones (colored squares) on the Master Zone Map can be configured as links. These links can either connect to a map of that specific slave unit/zone, or can connect directly to the web interface for the slave unit.</p> <p>Disabled - No active links within the Master Zone Map.</p> <p>Maps 2-10 - Link to preloaded image maps, which allows you to drill down into a graphical overview of the individual units.</p> <p>Slave Web Page - The LD5200 imports the links from the information entered on the Slave Controller Configuration page. This allows the links in the map to link directly to the web interfaces (when available) for those slave units.</p> <p>Default setting: Disabled</p>
Zone/Controller	<p>Designate the zone or controller with which this map corresponds. Zone/Controller 1 is reserved for the LD5200 you're working with.</p>
Map Alarm Coordinates - Text	<p>Click this link to adjust the mapped points based on their numerical coordinates. This is helpful if you wish to fine-tune mapped coordinates.</p>

Table 4.7 Map Settings Options

Option	Description
Map Alarm Coordinates - Graphical	Use this link to designate mapped points with the uploaded image.
Map Alarm Test	Click this link to view a test map, with all mapped points displayed in their alarm state.
User Image File	This non-editable field reports the name and size of the image currently uploaded.
Delete Image #	Use this button to delete the uploaded image.
Image	<p>Click the Browse or Choose File button to locate the prepared floor map on your system.</p> <p>Acceptable file formats: .jpeg, .jpg, .bmp, .png, and .gif. .pdf and .vsd files can be uploaded for reference, but cannot support interactive mapping capabilities.</p> <p>File size: less than 500kb</p> <p>Maximum physical size: 4000x4000 pixels</p> <p>Select the correct file and click the Upload button to load the file onto the LD5200.</p>

Table 4.7 Map Settings Options

Several options on this page fall above the gray line that separates the image upload section of the page. If you edit any of the fields above the line, be sure to press the **Submit Changes** button to save your edits before you upload an image. If you click the Upload button without submitting your changes, all your edits will be lost.

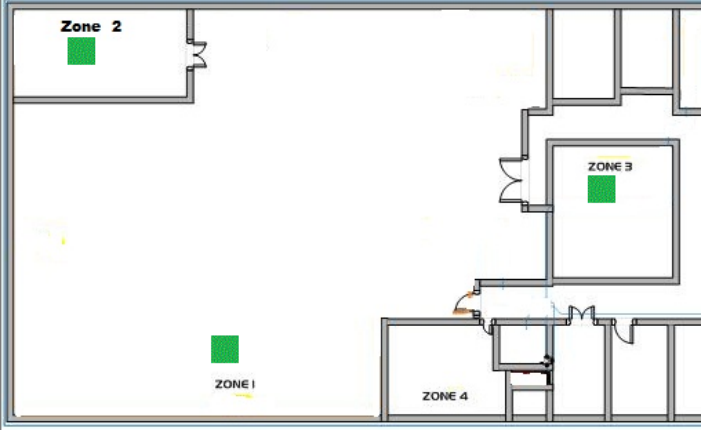
4.3.8.1 Upload the Map Image

- 1 From the Map Configuration page, click the **Browse** or **Choose File** button. Depending on which browser you're using, this button may have different names.

- 2 Locate and select the map file you have previously created and saved. Click the **Open** button. The path and name of the map file displays in the field next to the Browse button.

Figure 4.15 Map Configuration Page

- 3 Click the **Upload** button.

The upload should take about seven seconds. Once the image of the map has uploaded, the LD5200 displays a message confirming that it has uploaded the new file.

File has been uploaded and copied to flash

If your browser does not automatically redirect you, please click [here](#).

Figure 4.16 Map Image Upload Message

If you receive the following error message, the file did not upload:

Map image file has been uploaded - but type is unknown

If your browser does not automatically redirect you, please click [here](#).

Figure 4.17 Map Image Upload Error Message

If the upload fails, return to the Map Configuration page, verify your file's size and type, and repeat the upload process.

4.3.8.2 Map Reference Points

Once the map image has been uploaded, make sure you've designated it as interactive (clicked the **Yes** radio button next to the Floor Map Interactive option), entered the text that you'd like to see on the link for the map (the Floor Map Link Text field) and clicked the **Submit Changes** button to save these edits. Now you're ready to designate reference points on the map.

Throughout the mapping process, you will use a set of crosshairs to designate the location of your mapped points. The LD5200 firmware interprets the area directly in the center of the crosshairs as your reference point. Therefore, the point you're mapping appears on the map wherever the center of the crosshairs is located when you click the mouse to designate the object's location.

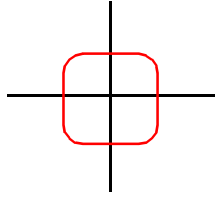

Figure 4.18 Mapping Crosshairs - Reference Point

When mapped, reference points appear on the map as follows:

Point	Map Display
Leak detected	Red square in the leak's location. The square does not appear on the map until a leak is detected.

Figure 4.19 Map Key

- 1 Click the Map Alarm Coordinates - Graphical link on the Map Configuration web page.

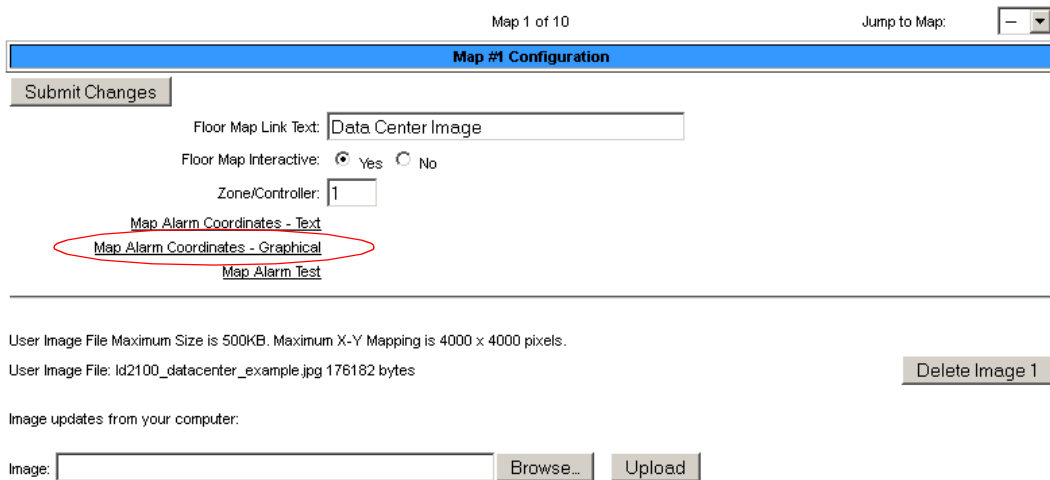

Figure 4.20 Graphical Mapping Link

- 2 The Graphical Mapping link takes you to a view of your map image. This is where you'll designate the physical locations of your mapped coordinates. In the "Enter a distance" box

at the top of the webpage, type 0 to set the reference point for the beginning of the cable run.



Figure 4.21 Mark the Beginning of the Cable Run

- 3 As you drag your mouse over the image, note that crosshairs appear. Use these crosshairs to pinpoint the location of the first coordinate. Click on the map in the location of the 0 point of the cable. When you click on the map, the distance and x,y coordinates are stored by the LD5200 and associated with the distance you entered into the box at the top of the screen. Once the data has been saved, the map will reload, and the coordinate count at the top of the screen will increase by 1.

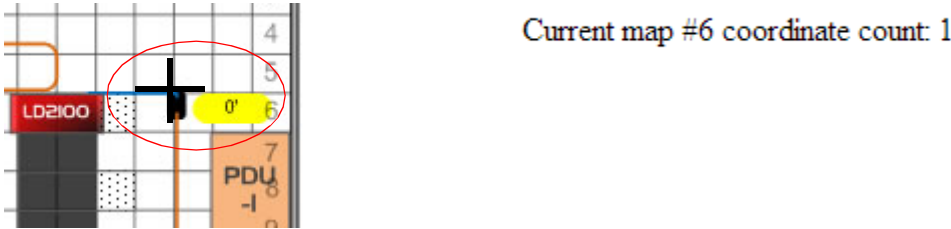

Figure 4.22 Crosshairs Designate the Mapped Coordinate

- 4 Enter the next distance to be recorded and click on the map in the corresponding location. Repeat this step for each reference point you wish to add to the map. **It is especially important to click on the map and designate a distance each time the cable changes direction.** When all the points have been mapped, click the **Return** link at the top of the page to return to the Map Configuration page.

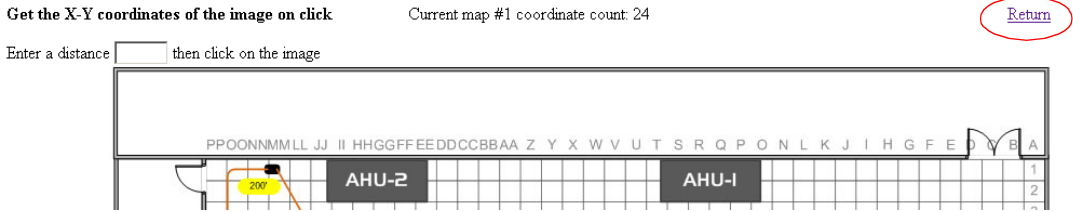

Figure 4.23 Coordinates Have Been Mapped - Return to the Map Configuration Page

4.3.8.3 Test the Mapped Coordinates

Return to the Map Configuration page and click the **Map Alarm Test** button. This will launch a new tab in your browser that displays your map with all your mapped coordinates, along

with their distance measurements. This demonstrates what the coordinates will look like when an alarm condition occurs.

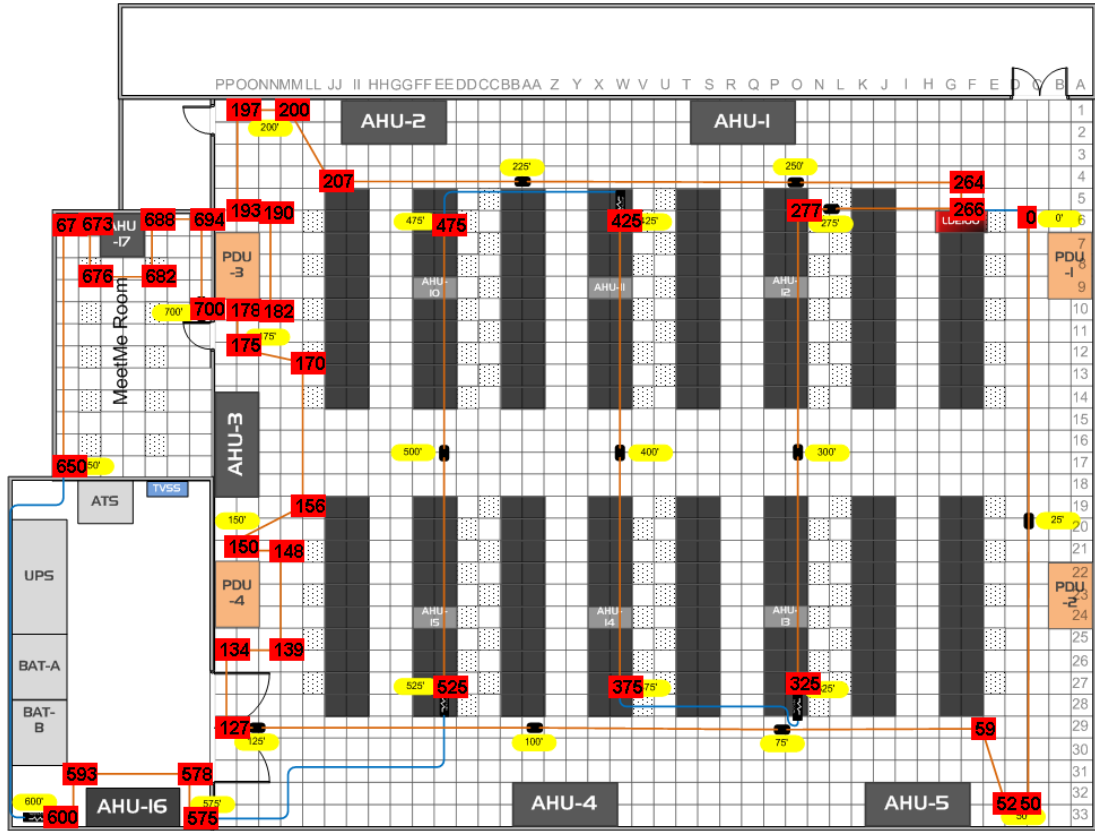

Figure 4.24 Click the Map Alarm Test Link to View All Mapped Points in an Alarm State

If any coordinates need to be adjusted, you can fine tune them through the Map Alarm Coordinates - Text link on the Map Configuration page. Click this link to display all the mapped coordinates and the distance readings associated with them.

Map #1 Alarm Coordinates			
Page 1 of 10		Jump to page: <input type="text" value="1"/>	
<input type="button" value="Submit Changes"/>			
Index	Distance	X-Coordinate	Y-Coordinate
1	<input type="text" value="0"/>	<input type="text" value="900"/>	<input type="text" value="183"/>
2	<input type="text" value="25"/>	<input type="text" value="899"/>	<input type="text" value="452"/>
3	<input type="text" value="50"/>	<input type="text" value="894"/>	<input type="text" value="705"/>
4	<input type="text" value="75"/>	<input type="text" value="680"/>	<input type="text" value="639"/>
5	<input type="text" value="100"/>	<input type="text" value="460"/>	<input type="text" value="638"/>
6	<input type="text" value="125"/>	<input type="text" value="216"/>	<input type="text" value="637"/>
7	<input type="text" value="150"/>	<input type="text" value="200"/>	<input type="text" value="475"/>
8	<input type="text" value="175"/>	<input type="text" value="200"/>	<input type="text" value="296"/>
9	<input type="text" value="200"/>	<input type="text" value="239"/>	<input type="text" value="90"/>
10	<input type="text" value="225"/>	<input type="text" value="449"/>	<input type="text" value="154"/>
11	<input type="text" value="250"/>	<input type="text" value="693"/>	<input type="text" value="156"/>
12	<input type="text" value="275"/>	<input type="text" value="723"/>	<input type="text" value="179"/>
13	<input type="text" value="300"/>	<input type="text" value="696"/>	<input type="text" value="393"/>
14	<input type="text" value="325"/>	<input type="text" value="697"/>	<input type="text" value="604"/>
15	<input type="text" value="375"/>	<input type="text" value="538"/>	<input type="text" value="602"/>
16	<input type="text" value="400"/>	<input type="text" value="538"/>	<input type="text" value="393"/>
17	<input type="text" value="425"/>	<input type="text" value="540"/>	<input type="text" value="190"/>
18	<input type="text" value="475"/>	<input type="text" value="383"/>	<input type="text" value="190"/>
19	<input type="text" value="500"/>	<input type="text" value="383"/>	<input type="text" value="395"/>
20	<input type="text" value="525"/>	<input type="text" value="383"/>	<input type="text" value="599"/>
<input type="button" value="Delete All Coordinates"/>			
<input type="button" value="Return"/>			

Edit the x, y, and distance values as necessary. To delete a coordinate, change all its values to 0. Click the Delete All Coordinates button to clear all the fields. Click the **Submit Changes** button to save all modifications.

4.3.8.4 Viewing the Map

Once you have given the map a title, the title appears on the Home page as an active button below the map image. If you have uploaded and titled two images, two buttons appear below the main map (the map loaded into Image index 1).

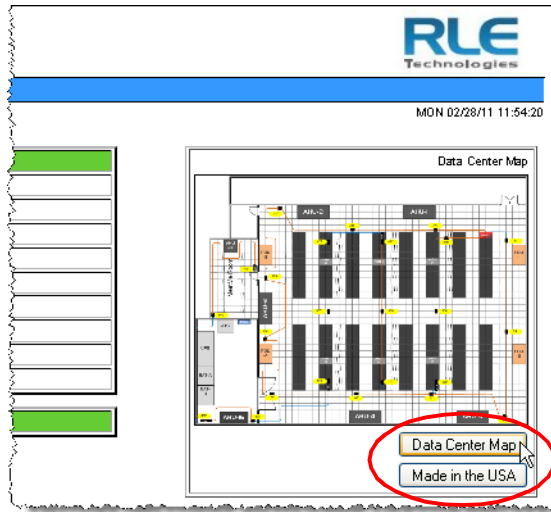

Figure 4.25 Map (Image) Buttons on Home Page

To view an enlargement of an image, click the button for the image you want to enlarge. The enlarged image displays in a new browser window.

4.3.9 Clock

Use this link to adjust the date and time, as needed. Click the **Submit Changes** button to save all modifications.

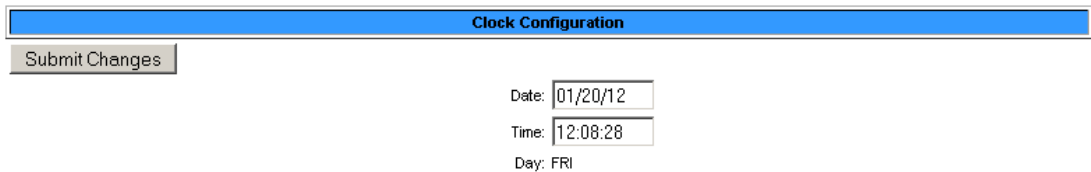

Figure 4.26 Clock Configuration Page

Option	Description
Date	Adjust the current date, in mm/dd/yy format, if necessary.
Time	Adjust the current time, in hh:mm:ss format, if necessary.
Day	A non-configurable field, the day of the week is generated based on the date.

Table 4.8 Clock Configuration Options

4.3.10 NTP

NTP, or Network Time Protocol, is used to synchronize clocks of computer systems. NTP synchronizes the time of a computer or device (the LD5200) with another computer or referenced time source. NTP maintains a high level of accuracy and reliability in time stamped events.

Network Time Protocol (NTP) Configuration

NTP Server:
(IP address or hostname)

Update Interval: Hours (0 for disabled)

Select Time Zone:

Daylight Savings Time:

DST Begin Date:

DST End Date:

```

Mail Server DNS address logged for: "na0100.smtpout.com" 208.70.89.156
Mail Server Dns TTL: 46067
Ntp Server DNS address logged for: "pool.ntp.org" 216.45.57.38
Ntp Server Dns TTL: 316

sysUpHours: 240
LastNtpRequestTime: 241
LastNtpResponseTime: 241
      
```

Figure 4.27 NTP Configuration Page

Option	Description
NTP Server	The IP address or hostname of the NTP server with which your LD5200 will synchronize. Public NTP servers include us.pool.ntp.org and time.nist.gov Default setting: blank
Update Interval	Designate how often you'd like the LD5200 to access and synchronize with the NTP server. Enter a 0 to disable this feature. Default setting: 0 (disabled)
Select Time Zone	Select the time zone in which this particular LD5200 resides. Default setting: Western European (UTC + 0)
Daylight Savings Time	Enable or disable Daylight Savings Time, and designate at which time DST goes into effect in your time zone. Default setting: Disabled

Table 4.9 NTP Configuration Options

Option	Description
DST Begin Date	Set the day DST begins at your location. Default setting: Second Sunday - March
DST End Date	Set the day DST ends at your location. Default setting: First Sunday - November

Table 4.9 [NTP Configuration Options](#)

4.3.11 Email-SMTP/DNS

Configure email and SMTP settings through this page.

Email Configuration

Submit Changes

Access Type: None LAN

Options: Email Contamination Alarms

Primary DNS Server:

Secondary DNS Server:

Mail (SMTP) Server:

Smtp Port: (Default 0 = 25)

Mail Sender Address:

Mail Subject:

Mail Recipient (1):

Mail Recipient (2):

Mail Recipient (3):

Mail Recipient (4):

Smtp Authentication: None Plain Login (Do not enable this unless instructed by your ISP or IT dept!)

Smtp Username:

Smtp Password:

(Email is disabled) Alarm History Entries: 240 Emails sent: 90 Emails unsent: 0

Mail Server DNS address logged for: "na0100.smtpout.com" 208.70.89.156
Mail Server Dns TTL: 45944
Ntp Server DNS address logged for: "pool.ntp.org" 216.45.57.38
Ntp Server Dns TTL: 203

[View Smtp Log / Send Test Email](#)

Figure 4.28 Email-SMTP/DNS Configuration Page

Option	Description
Access Type	Select LAN to send alerts through a local network connection. Select None to disable the email feature. Default setting: LAN
Options - Email Contamination Alarms	The LD5200 will send alerts for leak and cable break alarms. Decide if you'd also like to receive email alerts for contamination alarms. If so, check this box. If false alarms are often detected on your system, you may want to disable this function Default setting: checked (contamination alarms enabled)
Primary DNS Server	Enter the IP address for the primary DNS server, as provided by your internet service provider. Default setting: 0.0.0.0

Table 4.10 Email-SMTP/DNS Configuration Options

Option	Description
Secondary DNS Server	Enter the IP address for the secondary DNS server, as provided by your internet service provider. Default setting: 0.0.0.0
Smtp Port	Alternative port used for SMTP. 0 = Port 25 Default setting: 0 (Port 25)
Mail Sender Address	This is email sender address assigned to the LD5200.
Mail Subject	Text that appears in the subject line of the email message.
Mail Recipient (1)	The email address of the first recipient.
Mail Recipient (2)	The email address of the second recipient.
Mail Recipient (3)	The email address of the third recipient.
Mail Recipient (4)	The email address of the fourth recipient.
Smtp Authentication	Used for ESMTP. Use the default setting, unless otherwise directed by your IT department. Default setting: None
Smtp Username	Used for ESMTP. Use the default setting, unless otherwise directed by your IT department. Default setting: Blank
Smtp Password	Used for ESMTP. Use the default setting, unless otherwise directed by your IT department. Default setting: Blank
View Smtp Log / Send Test Email	View a log of all email messages that have been sent by the LD5200. This link provides access to a button that generates and sends a test email.

Table 4.10 Email-SMTP/DNS Configuration Options

4.3.12 SNMP/Syslog

Use this page to configure the LD5200 for SNMP communications.

SNMP/Syslog Configuration					
Submit Changes					
MIB-2 System					
System Name:	LD5200 Demo - username: ld5200 p/w: (leave blank)				
System Contact:	Maintenance Department800-555-1234maintenance@yourfacility.com				
System Location:	RLE Server Room, 104 Racquette Drive, Fort Collins, CO 80524				
V1/V2C Community Names					
Get/Read:	rletech				
Set/Write:	rletech				
Trap:	rletech				
Traps					
Select Snmp Trap Type:	V1-Trap				
Max Inform Retries:	0 (0-999) (0=unlimited)				
Inform Interval:	1 (1-999) (Minutes)				
Modbus Zone Traps:	<input type="radio"/> Enable <input checked="" type="radio"/> Disable				
Trap Destinations					
#	IP Address	TrapEnable	Syslog Message		
1	0.0.0.0	<input type="checkbox"/>	<input type="checkbox"/> (-)		
2	0.0.0.0	<input type="checkbox"/>	<input type="checkbox"/> (-)		
3	0.0.0.0	<input type="checkbox"/>	<input type="checkbox"/> (-)		
4	empty	<input type="checkbox"/>	<input type="checkbox"/> (-)		
SnmpV3					
Engine ID: 80000C700300905B04169D		Context Name:			
#	User Name	Access Mode	Auth-Password (8-24 chars)	Priv-Password (8-24 chars)	
1		No-Auth			
2		No-Auth			
3		No-Auth			
4		No-Auth			
Trap		No-Auth			
unsupportedSecurityLevel:0 / notInTimeWindow:0 / unknownUserName:0 unknownEngineID:5 / wrongDigest:0 / decryptionError:0					
Send Test Trap - Leak Detected		Send Test Trap - Cable Break		Send Test Trap - Contamination	

Figure 4.29 SNMP/Syslog Page

Option	Description
MIB-2 System Options	
System Name	Designate a unique name for the LD5200, up to 30 characters.
System Contact	Lists the individual responsible for the LD5200. Enter up to four lines of text (30 characters per line)
System Location	Enter the address of the LD5200's physical location.
V1/V2C Community Names	
Get/Read	Enter the appropriate community name.

Table 4.11 SNMP/Syslog Options

Option	Description
Set/Write	Enter the appropriate community name.
Trap	Enter the appropriate community name.
Traps Options	
Select Snmp Trap Type	Select the appropriate trap type from the following options: V1 - Trap, V2C - Trap, V2C - Inform, V3 - Trap, V3 - Inform Default setting: V1 -Trap
Max Inform Retries	The number of times the LD5200 will attempt to resend an undelivered trap. Enter a number 0 - 999. Enter 0 for an unlimited number of attempts. Default setting: 0 (unlimited)
Inform Interval	The number of minutes that passes between inform operations. Enter a number of minutes 1 - 999 Default setting: 1
Modbus Zone Traps	Enable or disable this function. Default setting: Disable
Trap Destinations	
IP Address	The IP address of the server to send the trap information to.
TrapEnable	Check this box to indicate that trap information should be sent to the specified server.
Syslog Message	Check this box to indicate that syslog messages should be sent to the specified server.
SnmpV3	
Engine ID	An uneditable field that lists the engine ID.
Context Name	Enter the alphanumeric name used for the SNMP v3 interface.
#	An uneditable field used to designate individual users.
User Name	Enter a unique name for each user.
Access Mode	Choose from the following: No Authentication Authentication - MD5 Privacy Authentication - MD5 A user name is need for No Authentication, and a user name and password are required for Authentication and Privacy Authentication access.
Auth-Password	Enter the authentication password - the password must be between 8 and 24 characters long.

Table 4.11 SNMP/Syslog Options

Option	Description
Priv-Password	Enter the privacy (encryption) password - the password must be between 8 and 24 characters long.
Send Test Trap - Leak Detected Send Test Trap - Cable Break Send Test Trap - Contamination	Use these buttons to send test traps - test your system setup to ensure all information has been entered correctly.

Table 4.11 [SNMP/Syslog Options](#)

4.3.13 EIA-485 Port/Modbus/N2

If the LD5200 will communicate via the EIA-485 port, configure the necessary options here.

Modbus/EIA-485 Configuration

Modbus/TCP/UDP Slave Unit Identifier: (1-254, 0 = disabled)

Enable Alarm Relay for Modbus Slaves: Enable Disable

EIA-485 Port1 Function:

EIA-485 Port1 Baud Rate: 9600 19200 38400

EIA-485 Port1 Slave Address: (1-254, 0 = disabled)

EIA-485 Port2 Function:

EIA-485 Port2 Baud Rate: 9600 19200 38400

Note: Port 1 & 2 cannot be individually set to 19200 and 38400

EIA-485 Port2 Slave Address: (1-254, 0 = disabled)

EIA-485 Port3 Function:

EIA-485 Port3 Baud Rate: 9600 19200 38400

EIA-485 Port3 Slave Address: (1-254, 0 = disabled)

[Modbus Slave Register Display Log](#)

[Modbus Statistics](#)

[Modbus Packet Log](#)

[N2 Register Display Log / Statistics](#)

Figure 4.30 Modbus EIA-485 Page

Option	Description
Modbus/TCP/UDP Slave Unit Identifier	This designator is used for Modbus RTU over an Ethernet connection. Set the slave unit identifier, 1-254. 0 = disabled.
Enable Alarm Relay for Modbus Slaves	Enable or disable this option Default setting: Disabled
EIA-485 Port 1 Function	Select Modbus-Slave or Modbus-Master
EIA-485 Port 1 Baud Rate	Selectable: 9600, 19200, or 38400
EIA-485 Port 1 Slave Address	Set the slave address, 1-254. 0 = disabled
EIA-485 Port 2 Function	Select Modbus Slave, Bacnet-MS/TP-Slave, Modbus-Master, or N2 (fixed, 9600, 8, n, 1)
EIA-485 Port 2 Baud Rate	Selectable: 9600, 19200, or 38400

Table 4.12 Modbus/EIA-485 Options

Option	Description
EIA-485 Port 2 Slave Address	Set the slave address, 1-254. 0 = disabled
EIA-485 Port 3 Function	Select Modbus-Slave or Modbus-Master
EIA-485 Port 3 Baud Rate	Selectable: 9600, 19200, or 38400
EIA-485 Port 3 Slave Address	Set the slave address, 1-254. 0 = disabled
Modbus Slave Register Display Log	Click these links to display the corresponding data.
Modbus Statistics	
Modbus Packet Log	
N2 Register Display Log / Statistics	

Table 4.12 [Modbus/EIA-485 Options](#)

4.3.14 Bacnet

The LD5200 can communicate via BACnet. BACnet allows building automation and control devices to communicate, regardless of the services they perform.

Bacnet Configuration

BACnet Device Name:

BACnet Device ID: (0 = Disabled)

BACnet Description:

Bacnet UDP Port: (0 = 47808)

Bacnet MS/TP Max Master: (0 = Slave Only)

Register as Foreign Device at IP: (Arp: na)

Registration Time-to-Live:

Foreign Device Table #1: 0.0.0.0 TTL: 0 TimeRemaining: 0
 Foreign Device Table #2: 0.0.0.0 TTL: 0 TimeRemaining: 0

Bacnet BBMD-BDT:
 LD5200 IP Address: 10.0.0.237:47808 Mask: 32 (FFFFFFF)

(Primary) #1 IP Address: Port: Mask: (1-32)
 #2 IP Address: Port: Mask: (1-32)
 #3 IP Address: Port: Mask: (1-32)
 #4 IP Address: Port: Mask: (1-32)

Bacnet Alarms Event Notification:

Recipient #1 IP Address: PD:

Notification Type: Unconfirmed Confirmed (Ack required)

Notification Class: Priority:

Leak Detected Alarms: Analog Binary

APDU_Timeout (seconds): Number_of_APDU_Retries:

Note: Be sure all changes have been submitted first.

Current Alarm Flags: Leak Detected 0x0, Cable Break 0x0, Contamination 0x0, Zone In Alarm 0x0
 (AckReceived 0x20, AckRequired 0x10, SimpleAckRcvd 0x08, AlarmSent 0x04, NewAlarm 0x02, CurrentAlarm 0x01)

MstpTokenPacketsIn: 15108379 MstpTokenPacketsOut: 7229233
 MstpDataPacketsIn: 48851 MstpDataPacketsOut: 21697
 TokenCount: 7067676

Bacnet/IP and MS/TP Objects

BI:1 Leak Alarm AI:1 Location Of Leak
 BI:2 Cable Break Alarm AI:2 Leakage Current On Cable
 BI:3 Contamination Alarm AI:3 Length Of Cable
 BI:4 Unit Of Measure
 (true=ft, false=meters)

Bacnet/IP Objects

TL:2 Trend-Log Leakage Current (ma 0.xxx) TL:3 Trend-Log Leakage Current (ua xxx)
 BI:201 Zone 2 Enabled AI:201 Zone 2 Location Of Leak
 BI:202 Zone 2 Leak Detected AI:202 Zone 2 Leakage Current
 BI:203 Zone 2 Cable Break AI:203 Zone 2 Length Of Cable
 BI:204 Zone 2 Contamination
 BI:205 Zone 2 Comm Loss
 .. Repeat for Zones 3-127 ..
 BI:12801 Zone 128 Enabled AI:12801 Zone 128 Location Of Leak
 BI:12802 Zone 128 Leak Detected AI:12802 Zone 128 Leakage Current
 BI:12803 Zone 128 Cable Break AI:12803 Zone 128 Length Of Cable
 BI:12804 Zone 128 Contamination
 BI:12805 Zone 128 Comm Loss

Property Identifiers Supported

BACnet_Present_Value	BACnet_Object_Identifier	BACnet_Object_Name
BACnet_Object_Type	BACnet_Out_Of_Service	BACnet_Units
BACnet_Status_Flags	BACnet_Event_State	

Bacnet Device Objects

BACnet_Object_Identifier	BACnet_Object_Name	BACnet_Object_Type
BACnet_System_Status	BACnet_Vendor_Name	BACnet_Vendor_Id
BACnet_Model_Name	BACnet_Firmware_Revision	BACnet_App_Software_Revision
BACnet_Location	BACnet_Description	BACnet_Protocol_Version
BACnet_Conformance_Class	BACnet_Services_Supported	BACnet_Object_Types_Supported
BACnet_Object_List	BACnet_Max_APDU	BACnet_Segment_Supported
BACnet_Segment_Timeout	BACnet_APDU_Timeout	BACnet_APDU_Retries
BACnet_Bindings		

[Bacnet Packet Log](#)

Figure 4.31 Bacnet Page

Option	Description
BACnet Device Name	Designate a unique name for the LD5200, up to 30 characters
BACnet Device ID	Set the device ID, up to 30 characters. 0 = disabled
BACnet Description	Enter a description for the device, up to 30 characters
Bacnet UDP Port	Enter a 0 to specify port 47808 (0xBAC0) as the UDP port. If another port is specified by your application, enter that value here. Default setting: 0
Bacnet MS/TP Max Master	Set the slave address, 1-127. 0 = Slave only Default setting: 0
Register as Foreign Device at IP	IP address of the master device with which you're trying to communicate. Requires a BBMD for foreign device discovery.
Registration Time-to-Live	Time, in seconds, for foreign device discovery.
Foreign Device Table #1 & #2	Fixed fields whose content is drawn from the entries in the Register Foreign Device and Registration T-t-L fields.
Bacnet BBMD-BDT	Used by some BACnet masters for discovery on different subnets.
LD5200 IP Address	Non-editable, this address is configured through the Network/IP link.
(Primary) #1 IP Address	Designate the appropriate IP addresses.
#2 IP Address	
#3 IP Address	
#4 IP Address	
Bacnet Alarms Event Notification	
Recipient #1 IP Address	When there is a BACnet alarm, a message will be sent to this address.
Notification Type	Select unconfirmed or confirmed. If you select confirmed, the recipient will be required to acknowledge the alarm. Default setting: Unconfirmed
Notification Class	A list of devices to be informed if an event enrollment object determines that a warning or alarm message needs to be sent.
Priority	Designate a priority to controls where conflicting control situations may occur.
Leak Detected Alarms	Select analog or binary
APDU_Timeout	Amount of time (milliseconds) between retransmissions of an APDU requiring acknowledgement for which no acknowledgement has been received.

Table 4.13 Bacnet Options

Option	Description
Number_of_APDU_Retries	The maximum number of times and APDU is retransmitted.
Send Test Alarms	Click this button to test your alarm configuration. Press the submit changes button before clicking this link, or all your BACnet configuration data will be lost.
Clear Test Alarms	Click this button to clear the test alarms once they have been sent and correctly received.

Table 4.13 Bacnet Options

4.3.15 Alarm Management

Use this page to manage and reset current alarms, messages, and alarm history.

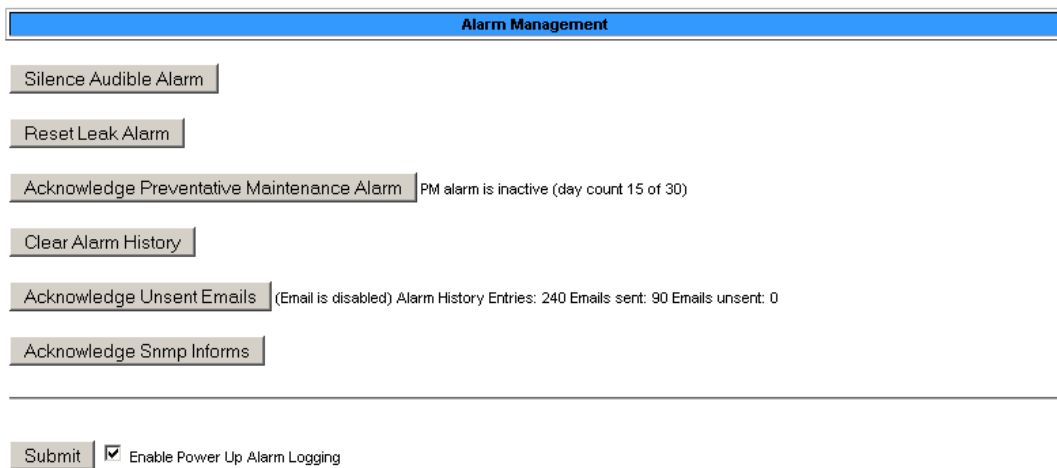

Figure 4.32 Alarm Management Page

Option	Description
Silence Audible Alarms	Click to silence the current audible alarm. This will not turn off the audible alarm permanently - that option is available on the Leak page.
Reset Leak Alarm	Resets the current leak alarm and causes the LD5200 to recheck the current cable conditions. This clears the alarm condition if the cable registers that the leak threshold is within an accepted range.
Acknowledge Preventative Maintenance Alarm	The preventative maintenance alarm is configured on the Leak page. Use this link to acknowledge the alarm once it is activated.
Clear Alarm History	View the alarm history through the Historical Data link at the top of the web interface. Click this button to clear the alarm history of all previous alarms.
Acknowledge Unsent Emails	Clears unsent emails so they aren't sent to recipients. Events are still logged in the historical data.
Acknowledge Snmp Informs	Acknowledges SNMP Informs and stops Informs from being sent out for the current alarm condition.

Table 4.14 Alarm Management Options

4.3.16 System/Flash Management

Use this page to update the LD5200's firmware, the front panel LCD's firmware, and to backup the LD5200's configuration file. Refer to Appendix A, "Update Firmware" on page 103 for complete firmware update instructions.

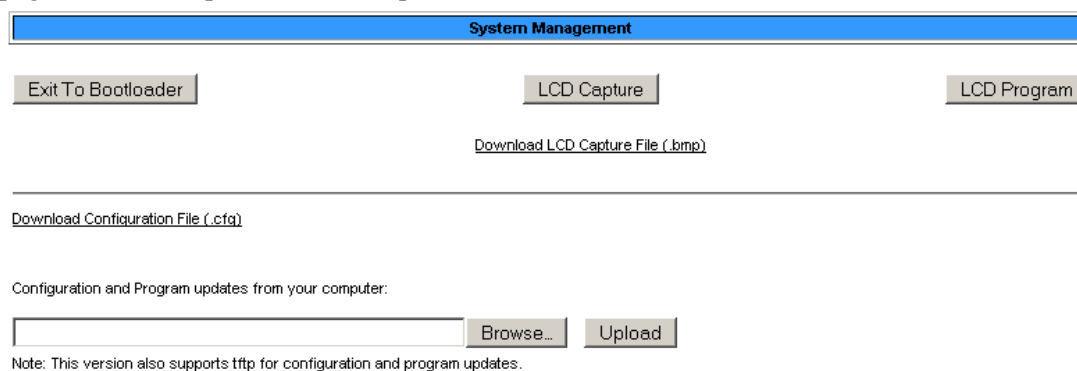

Figure 4.33 System/Flash Management Page

Option	Description
Exit to Bootloader	Access the bootloader.
LCD Capture	Use this button to download a .bmp image of the current front panel LCD screen. This operation takes about 30 seconds, and uses most of the processing power on the LD5200. For this reason, you will not be able to perform any other operations on the LD5200 while the capture executes.
Download LCD Capture File (.bmp)	Click this link to view the downloaded LCD capture image in your web browser.
LCD Program	Update the LCD screen's firmware.
Download Configuration File (.cfg)	Save a copy of the LD5200's configuration file to a local computer. Always save a copy of the .cfg file before you update the firmware on the LD5200.
Configuration and Program updates from your computer	Use this field to update the firmware on the LD5200. Refer to Appendix A, "Update Firmware" on page 103 for complete firmware update instructions.

Table 4.15 System/Flash Management Options

4.3.17 Product Registration

The Product Registration link routes users to the product registration form at rletech.com. Complete this form to receive product and firmware updates and support.

4.4 Historical Data

The Historical Data link provides access to logged historical data, including alarm and trending data. The LD5200’s historical data includes a time-stamped chronology of events and a trend log that contains occurrences of current leakage.

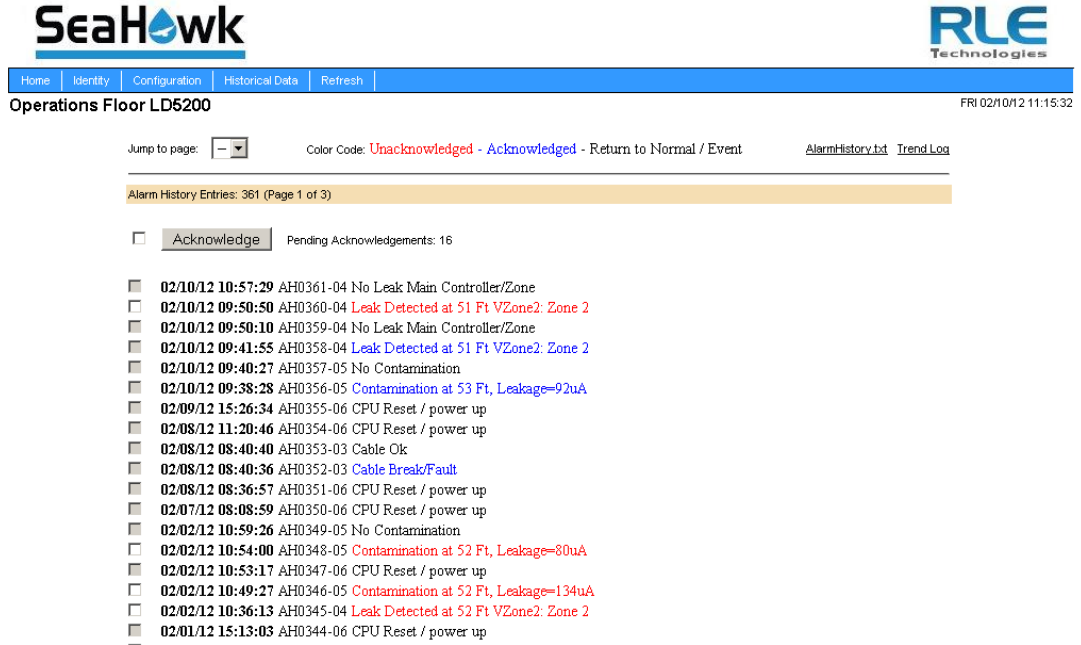

Figure 4.34 Historical Data Page

Option	Description
Jump to Page	Use this drop down menu to access additional pages of historical data.
AlarmHistory.txt	Click this link to download a copy of the alarm history in a .txt format.
Trend Log	View trend log data.
Acknowledge	Each acknowledgeable alarm event has a checkbox in front of it. Click individual checkboxes and press the Acknowledge button to acknowledge selected alarms. If you wish to acknowledge all alarms on the page, click the checkbox in front of the Acknowledge button (this will activate all the available checkboxes) and click the Acknowledge button.

Table 4.16 Historical Data Options

Each entry in the alarm history is recorded in the following format:

checkbox MM/DD/YY HH:MM:SS. AHxxxx-yy.

Item	Description
checkbox	The selected alarm will be acknowledged once the Acknowledge button is pressed. Only events with a white checkbox can be checked and acknowledged. Gray checkboxes are inactive.
date and time	Displayed as MM/DD/YY and HH:MM:SS (24 hour format)
AH	Stands for “alarm history”
xxxx	The log entry number for the alarm/event.
yy	The event code, which indicates the type of event, as follows: 03 – Cable Fault 04 – Leak Detected 05 – Contamination Detected 06 – Reset/Power Up
text	Provides details about the current alarm/event.

Table 4.17 Alarm History Log Description

Alarm history data is also available as a text file (.txt). Click the AlarmHistory.txt link to download the data as a text file.

```
LD5200 Alarm History
Operations Floor LD5200

AH0361-04-RETURN-02/10/12 10:57:29 No Leak Main Controller/Zone
AH0360-04-ALARM!-02/10/12 09:50:50 Leak Detected at 51 Ft VZone2: Zone 2
AH0359-04-RETURN-02/10/12 09:50:10 No Leak Main Controller/Zone
AH0358-04-ALARM!-02/10/12 09:41:55 Leak Detected at 51 Ft VZone2: Zone 2
AH0357-05-RETURN-02/10/12 09:40:27 No Contamination
AH0356-05-ALARM!-02/10/12 09:38:28 Contamination at 53 Ft, Leakage=92uA
AH0355-06-RETURN-02/09/12 15:26:34 CPU Reset / power up
AH0354-06-RETURN-02/08/12 11:20:46 CPU Reset / power up
AH0353-03-RETURN-02/08/12 08:40:40 Cable Ok
AH0352-03-ALARM!-02/08/12 08:40:36 Cable Break/Fault
AH0351-06-RETURN-02/08/12 08:36:57 CPU Reset / power up
AH0350-06-RETURN-02/07/12 08:08:59 CPU Reset / power up
AH0349-05-RETURN-02/02/12 10:59:26 No Contamination
AH0348-05-ALARM!-02/02/12 10:54:00 Contamination at 52 Ft, Leakage=80uA
AH0347-06-RETURN-02/02/12 10:53:17 CPU Reset / power up
AH0346-05-ALARM!-02/02/12 10:49:27 Contamination at 52 Ft, Leakage=134uA
AH0345-04-ALARM!-02/02/12 10:36:13 Leak Detected at 52 Ft VZone2: Zone 2
AH0344-06-RETURN-02/01/12 15:13:03 CPU Reset / power up
```

Figure 4.35 Alarm History Text File (.txt)

The Trend Log option provides a trending list of logged current leakage. This data provides assistance in troubleshooting leaks and inaccurate readings. Click the Trend Log link to access this information.

```
Trend Record_Count: 10 Total_Record_Count: 10 Buffer_Size: 365 Interval: 1440 (Minutes)

TD001-09/17/11 13:57:55 Leakage: 0 uA
TD002-09/18/11 14:28:50 Leakage: 0 uA
TD003-09/19/11 14:59:56 Leakage: 0 uA
TD004-09/20/11 19:17:23 Leakage: 0 uA
TD005-09/22/11 15:09:16 Leakage: 0 uA
TD006-12/18/11 17:24:10 Leakage: 0 uA
TD007-12/20/11 14:58:25 Leakage: 0 uA
TD008-12/21/11 15:32:01 Leakage: 0 uA
TD009-01/27/12 10:46:04 Leakage: 0 uA
TD010-02/09/12 14:04:16 Leakage: 0 uA
```

Figure 4.36 Trend Log

4.5 Refresh

Click the Refresh link to manually check for status updates. The LD5200 will refresh all its data, and poll all connected devices for their most recent data. The Refresh link is especially helpful if the system's refresh rate is set at a long interval, or when new equipment is connected to the system. Instead of waiting for the LD5200 to refresh on its own, click the link to force a system refresh.

To adjust the automatic refresh rate, refer to [Figure 4.12, "Web Configuration Page"](#) on page 60.

MODBUS COMMUNICATION

5.1 Comm Port Settings

The Modbus/EIA-485 Configuration Menu allows users to configure all three of the LD5200's EIA-485 Modbus ports. The LD5200 is configurable as both a Modbus master and a Modbus slave device. As a slave device, the LD5200 can have only one master. All three ports may have their addresses and baud rates set in this menu. All addresses may be different and can be configured from 0 (disabled) to 254. Baud rates can be different and can be configured as 9600 (default), 19200, or 38400. Settings can be configured through both the LCD and the web interface.

The Leak Detection Master option enables slave units to activate the LD5200 when they are triggered into an alarm state. This function is beneficial when the LD5200 is a remote system that does not have personnel in the immediate vicinity to monitor the alarm status.

When using the leak detection master option, the LD5200 relays can be activated according to the slave unit alarm. If the slave has a leak alarm or a cable break alarm, the LD5200 leak or cable relay will change state, respectively (i.e. it will trigger that an alarm is present). The zone will then appear on the LCD and an alarm state will be reported to the top level of the system.

5.2 Leak Detection Modbus Master

This feature allows the LD5200 to act as a Modbus master, so it can talk to other RLE distance read panels. The system status can be viewed by using the view zones menu. The LD5200 will display leak, cable break, cable contamination, and loss of communications alarms from the slave units connected to it.

5.2.1 Connect Distance Read Panels to the LD5200

Using a two wire configuration, connect the slave units in a 485 daisy chain. You will have to set the EIA-485 slave address in each Leak detection unit. The first unit connected must be set to address 2. The following units will increase in numeric order by one unit (e.g., the next unit would be set to address 3, the following would be set to address 4, etc.; see Figure 5.1.)

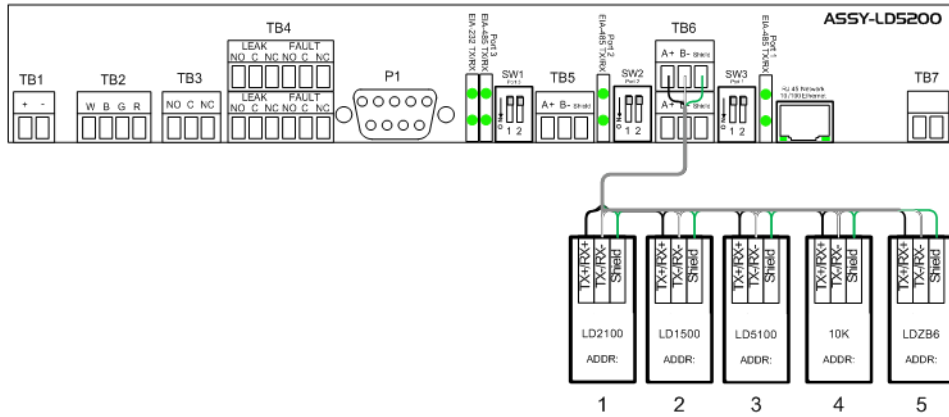

Figure 5.1 LD5200 Connection Diagram

5.3 Implementation Basics

The LD5200 is capable of communicating via the half-duplex EIA-485 serial communication standard. The EIA-485 medium allows for multiple devices on a multi-drop network.

5.3.1 Modes of Transmission

The Modbus protocol uses ASCII and RTU modes of transmission. The LD5200 supports only the RTU mode of transmission, with 8 data bits, no parity and one stop bit. Every Modbus packet consists of four fields:

- ◆ Slave Address Field
- ◆ Function Field
- ◆ Data Field
- ◆ Error Check Field (Checksum)

5.3.1.1 Slave Address Field

The slave address field is set by the going into local 160x160 display on the front panel. Go to COMM PORT SETTINGS from the Main Menu screen. Select the Modbus Slave address and the baud rate to be used for either/or EIA-485 Port1 and EIA-485 Port2.

5.3.1.2 Function Field

The function field is one byte in length and tells the LD5200 which function to perform. The supported functions are 03 (Read 4xxx output registers), 04 (Read 3xxx input registers), 06 (Preset single register) and 16 (Preset multiple registers).

5.3.1.3 Data Field

The data field of the request is a variable length depending on the function. The data fields for the LD5200 are 16-bit registers, transmitted high order byte first (big-endian).

5.3.1.4 Error Check (Checksum) Field

The checksum field lets the receiving device determine if the packet has transmission errors. The LD5200 RTU mode uses a 16-bit cyclic redundancy check (CRC-16).

Exception Responses

If a Modbus master sends an invalid command to the LD5200 or attempts to read an invalid register, an exception response is generated. The response packet will have the high order bit of the function code set to one. The data field of the exception response contains the exception error code.

Code	Name	Description
01	Illegal Function	The function code is not supported
02	Illegal Data Address	Attempt to access an invalid address
03	Illegal Data Value	Attempt to set a variable to an invalid value

Table 5.1 Exception Codes

5.4 Packet Communications For The LD5200

This section covers the registers, their names, and a brief description of what they refer to.

5.4.1 Function 03: Read Output Registers

To read the LD5200 parameter values, the master must send a Read Output Registers request packet. The Read Output Registers request packet specifies a start register and the number of registers to read. The start register is numbered from zero (40001 = zero, 40002 = one, etc).

Read Registers Request Packet	Read Registers Response Packet
Slave Address (1 byte)	Slave Address (1 byte)
03 (Function code) (1 byte)	03 (Function code) (1 byte)
Start Register (2 bytes)	Byte count (1 byte)
# of registers to read (2 bytes)	First register (2 bytes)
Crc Checksum (2 bytes)	Second register (2 bytes)
	...
	Crc Checksum (2 bytes)

Table 5.2 Read Output Registers Packet Structure

Register	Name	Description	Units	Range
40001	Leak Threshold	Trip current for leak alarm	25-295 uAmps	0-65535
40002	Contamination Threshold	Trip current for contamination alarm	20-295 uAmps	0-65535
40003	Spare			0-65535
40004	Spare			0-65535
40005	Spare			0-65535
40006	Spare			0-65535
40007	Spare			0-65535
40008	Spare			0-65535
40009	Spare			0-65535
40010	Spare			0-65535
40011	Spare			0-65535
40012	Spare			0-65535
40013	Spare			0-65535
40014	Spare			0-65535
40015	Spare			0-65535
40016	Leak Alarm Delay	Leak Alarm Delay	5-995 seconds	0-65535
40017	Contamination Alarm Delay	Contamination Alarm Delay	5-995 seconds	0-65535

Table 5.3 [Output Registers](#)

5.4.2 Function 04: Read Input Registers

To read the LD5200 input values, the master must send a Read Input Registers request packet.

The Read Input Registers request packet specifies a start register and the number of registers to read. The start register is numbered from zero (30001 = zero, 30002 = one, etc).

Read Registers Request Packet	Read Registers Response Packet
Slave Address (1 byte)	Slave Address (1 byte)
04 (Function code) (1 byte)	04 (Function code) (1 byte)
Start Register (2 bytes)	Byte count (1 byte)
# of registers to read (2 bytes)	First register (2 bytes)
Crc Checksum (2 bytes)	Second register (2 bytes)
	...
	Crc Checksum (2 bytes)

Table 5.4 Read Input Registers Packet Structure

Register	Name	Description	Units	Range
30001	Status	Bit level status 00 : 1 = Leak is Detected 01 : 1 = Cable Break Alarm 02 : 1 = Contamination is Detected 03-15 : Spare	None	0-65535
30002	Leak Distance	Location of leak	Ft/Meters	0-65535
30003	Units	Unit of measure	1=Ft 0=Meters	0-65535
30004	Leak Current	Leakage current on cable	uAmps	0-65535
30005	Cable Length	Installed cable length	Ft/Meters	0-65535
30006	Loop1 Resistance	Resistance of cable	Ohms	0-65535
30007	Loop2 Resistance	Resistance of cable	Ohms	0-65535
30008	Resistance per Foot	Resistance of cable	Ohms x1000	0-65535
30009	Firmware Version	Firmware version	xx.xx X 100	0-65535
30010	Virtual Zone Alarm Status (00=Zone1...15=Zone16)	Bit Level Status Zone 1 through Zone 16	None	0-65535
30011	Virtual Zone Alarm Status (00=Zone17...15=Zone32)	Bit Level Status Zone 17 through Zone 32	None	0-65535
38001	Leak Location Float Value	Location of leak in meters (float-MSW)	Meters	0-65535
38002	Leak Location Float Value	Location of leak in meters (float-LSW)	Meters	0-65535
30012	Modbus Zone Enabled Flags (00=Modbus Zone 2... 15=Modbus Zone 16)	Bit Level Status Modbus Zone 2 through Modbus Zone 16	None	0-65535
30013	Modbus Zone2 Status	Bit Level Status	None	0-65535
30014	Modbus Zone2 Distance	Location of leak	Ft/Meters	0-65535
30015	Modbus Zone3 Status	Bit Level Status	None	0-65535
30016	Modbus Zone3 Distance	Location of leak	Ft/Meters	0-65535
30017	Modbus Zone4 Status	Bit Level Status	None	0-65535
30018	Modbus Zone4 Distance	Location of leak	Ft/Meters	0-65535
30019	Modbus Zone5 Status	Bit Level Status	None	0-65535
30020	Modbus Zone5 Distance	Location of leak	Ft/Meters	0-65535
30021	Modbus Zone6 Status	Bit Level Status	None	0-65535
30022	Modbus Zone6 Distance	Location of leak	Ft/Meters	0-65535
30023	Modbus Zone7 Status	Bit Level Status	None	0-65535

Table 5.5 Input Registers

Register	Name	Description	Units	Range
30024	Modbus Zone7 Distance	Location of leak	Ft/Meters	0-65535
30025	Modbus Zone8 Status	Bit Level Status	None	0-65535
30026	Modbus Zone8 Distance	Location of leak	Ft/Meters	0-65535
30027	Modbus Zone9 Status	Bit Level Status	None	0-65535
30028	Modbus Zone9 Distance	Location of leak	Ft/Meters	0-65535
30029	Modbus Zone10 Status	Bit Level Status	None	0-65535
30030	Modbus Zone10 Distance	Location of leak	Ft/Meters	0-65535
30031	Modbus Zone11 Status	Bit Level Status	None	0-65535
30032	Modbus Zone11 Distance	Location of leak	Ft/Meters	0-65535
30033	Modbus Zone12 Status	Bit Level Status	None	0-65535
30034	Modbus Zone12 Distance	Location of leak	Ft/Meters	0-65535
30035	Modbus Zone13 Status	Bit Level Status	None	0-65535
30036	Modbus Zone13 Distance	Location of leak	Ft/Meters	0-65535
30037	Modbus Zone14 Status	Bit Level Status	None	0-65535
30038	Modbus Zone14 Distance	Location of leak	Ft/Meters	0-65535
30039	Modbus Zone15 Status	Bit Level Status	None	0-65535
30040	Modbus Zone15 Distance	Location of leak	Ft/Meters	0-65535
30041	Modbus Zone16 Status	Bit Level Status	None	0-65535
30042	Modbus Zone16 Distance	Location of leak	Ft/Meters	0-65535
30043	Modbus Zone Enabled Flags (00=Modbus Zone 17... 15=Modbus Zone 32)	Bit Level Status Modbus Zone 17 through Modbus Zone 32	None	0-65535
30044	Modbus Zone17 Status	Bit Level Status	None	0-65535
30045	Modbus Zone17 Distance	Location of leak	Ft/Meters	0-65535
30046	Modbus Zone18 Status	Bit Level Status	None	0-65535
30047	Modbus Zone18 Distance	Location of leak	Ft/Meters	0-65535
30048	Modbus Zone19 Status	Bit Level Status	None	0-65535
30049	Modbus Zone19 Distance	Location of leak	Ft/Meters	0-65535
30050	Modbus Zone20 Status	Bit Level Status	None	0-65535
30051	Modbus Zone20 Distance	Location of leak	Ft/Meters	0-65535
30052	Modbus Zone21 Status	Bit Level Status	None	0-65535
30053	Modbus Zone21 Distance	Location of leak	Ft/Meters	0-65535
30054	Modbus Zone22 Status	Bit Level Status	None	0-65535
30055	Modbus Zone22 Distance	Location of leak	Ft/Meters	0-65535
30056	Modbus Zone23 Status	Bit Level Status	None	0-65535
30057	Modbus Zone23 Distance	Location of leak	Ft/Meters	0-65535
30058	Modbus Zone24 Status	Bit Level Status	None	0-65535

Table 5.5 Input Registers (continued)

Register	Name	Description	Units	Range
30059	Modbus Zone24 Distance	Location of leak	Ft/Meters	0-65535
30060	Modbus Zone25 Status	Bit Level Status	None	0-65535
30061	Modbus Zone25 Distance	Location of leak	Ft/Meters	0-65535
30062	Modbus Zone26 Status	Bit Level Status	None	0-65535
30063	Modbus Zone26 Distance	Location of leak	Ft/Meters	0-65535
30064	Modbus Zone27 Status	Bit Level Status	None	0-65535
30065	Modbus Zone27 Distance	Location of leak	Ft/Meters	0-65535
30066	Modbus Zone28 Status	Bit Level Status	None	0-65535
30067	Modbus Zone28 Distance	Location of leak	Ft/Meters	0-65535
30068	Modbus Zone29 Status	Bit Level Status	None	0-65535
30069	Modbus Zone29 Distance	Location of leak	Ft/Meters	0-65535
30070	Modbus Zone30 Status	Bit Level Status	None	0-65535
30071	Modbus Zone30 Distance	Location of leak	Ft/Meters	0-65535
30072	Modbus Zone31 Status	Bit Level Status	None	0-65535
30073	Modbus Zone31 Distance	Location of leak	Ft/Meters	0-65535
30074	Modbus Zone32 Status	Bit Level Status	None	0-65535
30075	Modbus Zone32 Distance	Location of leak	Ft/Meters	0-65535
30076	Modbus Zone Enabled Flags (00=Modbus Zone 33... 15=Modbus Zone 48)	Bit Level Status Modbus Zone 33 through Modbus Zone 48	None	0-65535
30077	Modbus Zone33 Status	Bit Level Status	None	0-65535
30078	Modbus Zone33 Distance	Location of leak	Ft/Meters	0-65535
30079	Modbus Zone34 Status	Bit Level Status	None	0-65535
30080	Modbus Zone34 Distance	Location of leak	Ft/Meters	0-65535
30081	Modbus Zone35 Status	Bit Level Status	None	0-65535
30082	Modbus Zone35 Distance	Location of leak	Ft/Meters	0-65535
30083	Modbus Zone36 Status	Bit Level Status	None	0-65535
30084	Modbus Zone36 Distance	Location of leak	Ft/Meters	0-65535
30085	Modbus Zone37 Status	Bit Level Status	None	0-65535
30086	Modbus Zone37 Distance	Location of leak	Ft/Meters	0-65535
30087	Modbus Zone38 Status	Bit Level Status	None	0-65535
30088	Modbus Zone38 Distance	Location of leak	Ft/Meters	0-65535
30089	Modbus Zone39 Status	Bit Level Status	None	0-65535
30090	Modbus Zone39 Distance	Location of leak	Ft/Meters	0-65535
30091	Modbus Zone40 Status	Bit Level Status	None	0-65535
30092	Modbus Zone40 Distance	Location of leak	Ft/Meters	0-65535
30093	Modbus Zone41 Status	Bit Level Status	None	0-65535

Table 5.5 Input Registers (continued)

Register	Name	Description	Units	Range
30094	Modbus Zone41 Distance	Location of leak	Ft/Meters	0-65535
30095	Modbus Zone42 Status	Bit Level Status	None	0-65535
30096	Modbus Zone42 Distance	Location of leak	Ft/Meters	0-65535
30097	Modbus Zone43 Status	Bit Level Status	None	0-65535
30098	Modbus Zone43 Distance	Location of leak	Ft/Meters	0-65535
30099	Modbus Zone44 Status	Bit Level Status	None	0-65535
30100	Modbus Zone44 Distance	Location of leak	Ft/Meters	0-65535
30101	Modbus Zone45 Status	Bit Level Status	None	0-65535
30102	Modbus Zone45 Distance	Location of leak	Ft/Meters	0-65535
30103	Modbus Zone46 Status	Bit Level Status	None	0-65535
30104	Modbus Zone46 Distance	Location of leak	Ft/Meters	0-65535
30105	Modbus Zone47 Status	Bit Level Status	None	0-65535
30106	Modbus Zone47 Distance	Location of leak	Ft/Meters	0-65535
30107	Modbus Zone48 Status	Bit Level Status	None	0-65535
30108	Modbus Zone48 Distance	Location of leak	Ft/Meters	0-65535
30109	Modbus Zone Enabled Flags (00=Modbus Zone 49... 15=Modbus Zone 64)	Bit Level Status Modbus Zone 49 through Modbus Zone 64	None	0-65535
30110	Modbus Zone49 Status	Bit Level Status	None	0-65535
30111	Modbus Zone49 Distance	Location of leak	Ft/Meters	0-65535
30112	Modbus Zone50 Status	Bit Level Status	None	0-65535
30113	Modbus Zone50 Distance	Location of leak	Ft/Meters	0-65535
30114	Modbus Zone51 Status	Bit Level Status	None	0-65535
30115	Modbus Zone51 Distance	Location of leak	Ft/Meters	0-65535
30116	Modbus Zone52 Status	Bit Level Status	None	0-65535
30117	Modbus Zone52 Distance	Location of leak	Ft/Meters	0-65535
30118	Modbus Zone53 Status	Bit Level Status	None	0-65535
30119	Modbus Zone53 Distance	Location of leak	Ft/Meters	0-65535
30120	Modbus Zone54 Status	Bit Level Status	None	0-65535
30121	Modbus Zone54 Distance	Location of leak	Ft/Meters	0-65535
30122	Modbus Zone55 Status	Bit Level Status	None	0-65535
30123	Modbus Zone55 Distance	Location of leak	Ft/Meters	0-65535
30124	Modbus Zone56 Status	Bit Level Status	None	0-65535
30125	Modbus Zone56 Distance	Location of leak	Ft/Meters	0-65535
30126	Modbus Zone57 Status	Bit Level Status	None	0-65535
30127	Modbus Zone57 Distance	Location of leak	Ft/Meters	0-65535
30128	Modbus Zone58 Status	Bit Level Status	None	0-65535

Table 5.5 Input Registers (continued)

Register	Name	Description	Units	Range
30129	Modbus Zone58 Distance	Location of leak	Ft/Meters	0-65535
30130	Modbus Zone59 Status	Bit Level Status	None	0-65535
30131	Modbus Zone59 Distance	Location of leak	Ft/Meters	0-65535
30132	Modbus Zone60 Status	Bit Level Status	None	0-65535
30133	Modbus Zone60 Distance	Location of leak	Ft/Meters	0-65535
30134	Modbus Zone61 Status	Bit Level Status	None	0-65535
30135	Modbus Zone61 Distance	Location of leak	Ft/Meters	0-65535
30136	Modbus Zone62 Status	Bit Level Status	None	0-65535
30137	Modbus Zone62 Distance	Location of leak	Ft/Meters	0-65535
30138	Modbus Zone63 Status	Bit Level Status	None	0-65535
30139	Modbus Zone63 Distance	Location of leak	Ft/Meters	0-65535
30140	Modbus Zone64 Status	Bit Level Status	None	0-65535
30141	Modbus Zone64 Distance	Location of leak	Ft/Meters	0-65535
30142	Modbus Zone Enabled Flags (00=Modbus Zone 65... 15=Modbus Zone 80)	Bit Level Status Modbus Zone 65 through Modbus Zone 80	None	0-65535
30143	Modbus Zone65 Status	Bit Level Status	None	0-65535
30144	Modbus Zone65 Distance	Location of leak	Ft/Meters	0-65535
30145	Modbus Zone66 Status	Bit Level Status	None	0-65535
30146	Modbus Zone66 Distance	Location of leak	Ft/Meters	0-65535
30147	Modbus Zone67 Status	Bit Level Status	None	0-65535
30148	Modbus Zone67 Distance	Location of leak	Ft/Meters	0-65535
30149	Modbus Zone68 Status	Bit Level Status	None	0-65535
30150	Modbus Zone68 Distance	Location of leak	Ft/Meters	0-65535
30151	Modbus Zone69 Status	Bit Level Status	None	0-65535
30152	Modbus Zone69 Distance	Location of leak	Ft/Meters	0-65535
30153	Modbus Zone70 Status	Bit Level Status	None	0-65535
30154	Modbus Zone70 Distance	Location of leak	Ft/Meters	0-65535
30155	Modbus Zone71 Status	Bit Level Status	None	0-65535
30156	Modbus Zone71 Distance	Location of leak	Ft/Meters	0-65535
30157	Modbus Zone72 Status	Bit Level Status	None	0-65535
30158	Modbus Zone72 Distance	Location of leak	Ft/Meters	0-65535
30159	Modbus Zone73 Status	Bit Level Status	None	0-65535
30160	Modbus Zone73 Distance	Location of leak	Ft/Meters	0-65535
30161	Modbus Zone74 Status	Bit Level Status	None	0-65535
30162	Modbus Zone74 Distance	Location of leak	Ft/Meters	0-65535
30163	Modbus Zone75 Status	Bit Level Status	None	0-65535

Table 5.5 Input Registers (continued)

Register	Name	Description	Units	Range
30164	Modbus Zone75 Distance	Location of leak	Ft/Meters	0-65535
30165	Modbus Zone76 Status	Bit Level Status	None	0-65535
30166	Modbus Zone76 Distance	Location of leak	Ft/Meters	0-65535
30167	Modbus Zone77 Status	Bit Level Status	None	0-65535
30168	Modbus Zone77 Distance	Location of leak	Ft/Meters	0-65535
30169	Modbus Zone78 Status	Bit Level Status	None	0-65535
30170	Modbus Zone78 Distance	Location of leak	Ft/Meters	0-65535
30171	Modbus Zone79 Status	Bit Level Status	None	0-65535
30172	Modbus Zone79 Distance	Location of leak	Ft/Meters	0-65535
30173	Modbus Zone80 Status	Bit Level Status	None	0-65535
30174	Modbus Zone80 Distance	Location of leak	Ft/Meters	0-65535
30175	Modbus Zone Enabled Flags (00=Modbus Zone 81... 15=Modbus Zone 96)	Bit Level Status Modbus Zone 81 through Modbus Zone 96	None	0-65535
30176	Modbus Zone81 Status	Bit Level Status	None	0-65535
30177	Modbus Zone81Distance	Location of leak	Ft/Meters	0-65535
30178	Modbus Zone82 Status	Bit Level Status	None	0-65535
30179	Modbus Zone82 Distance	Location of leak	Ft/Meters	0-65535
30180	Modbus Zone83 Status	Bit Level Status	None	0-65535
30181	Modbus Zone83 Distance	Location of leak	Ft/Meters	0-65535
30182	Modbus Zone84 Status	Bit Level Status	None	0-65535
30183	Modbus Zone84 Distance	Location of leak	Ft/Meters	0-65535
30184	Modbus Zone85 Status	Bit Level Status	None	0-65535
30185	Modbus Zone85 Distance	Location of leak	Ft/Meters	0-65535
30186	Modbus Zone86 Status	Bit Level Status	None	0-65535
30187	Modbus Zone86 Distance	Location of leak	Ft/Meters	0-65535
30188	Modbus Zone87 Status	Bit Level Status	None	0-65535
30189	Modbus Zone87 Distance	Location of leak	Ft/Meters	0-65535
30190	Modbus Zone88 Status	Bit Level Status	None	0-65535
30191	Modbus Zone88 Distance	Location of leak	Ft/Meters	0-65535
30192	Modbus Zone89 Status	Bit Level Status	None	0-65535
30193	Modbus Zone89 Distance	Location of leak	Ft/Meters	0-65535
30194	Modbus Zone90 Status	Bit Level Status	None	0-65535
30195	Modbus Zone90 Distance	Location of leak	Ft/Meters	0-65535
30196	Modbus Zone91 Status	Bit Level Status	None	0-65535
30197	Modbus Zone91 Distance	Location of leak	Ft/Meters	0-65535
30198	Modbus Zone92 Status	Bit Level Status	None	0-65535

Table 5.5 Input Registers (continued)

Register	Name	Description	Units	Range
30199	Modbus Zone92 Distance	Location of leak	Ft/Meters	0-65535
30200	Modbus Zone93 Status	Bit Level Status	None	0-65535
30201	Modbus Zone93 Distance	Location of leak	Ft/Meters	0-65535
30202	Modbus Zone94 Status	Bit Level Status	None	0-65535
30203	Modbus Zone94 Distance	Location of leak	Ft/Meters	0-65535
30204	Modbus Zone95 Status	Bit Level Status	None	0-65535
30205	Modbus Zone95 Distance	Location of leak	Ft/Meters	0-65535
30206	Modbus Zone96 Status	Bit Level Status	None	0-65535
30207	Modbus Zone96 Distance	Location of leak	Ft/Meters	0-65535
30208	Modbus Zone Enabled Flags (00=Modbus Zone 97... 15=Modbus Zone 112)	Bit Level Status Modbus Zone 97 through Modbus Zone 112	None	0-65535
30209	Modbus Zone97 Status	Bit Level Status	None	0-65535
30210	Modbus Zone97 Distance	Location of leak	Ft/Meters	0-65535
30211	Modbus Zone98 Status	Bit Level Status	None	0-65535
30212	Modbus Zone98 Distance	Location of leak	Ft/Meters	0-65535
30213	Modbus Zone99 Status	Bit Level Status	None	0-65535
30214	Modbus Zone99 Distance	Location of leak	Ft/Meters	0-65535
30215	Modbus Zone100 Status	Bit Level Status	None	0-65535
30216	Modbus Zone100 Distance	Location of leak	Ft/Meters	0-65535
30217	Modbus Zone101 Status	Bit Level Status	None	0-65535
30218	Modbus Zone101Distance	Location of leak	Ft/Meters	0-65535
30219	Modbus Zone102 Status	Bit Level Status	None	0-65535
30220	Modbus Zone102 Distance	Location of leak	Ft/Meters	0-65535
30221	Modbus Zone103 Status	Bit Level Status	None	0-65535
30222	Modbus Zone103 Distance	Location of leak	Ft/Meters	0-65535
30223	Modbus Zone104 Status	Bit Level Status	None	0-65535
30224	Modbus Zone104 Distance	Location of leak	Ft/Meters	0-65535
30225	Modbus Zone105 Status	Bit Level Status	None	0-65535
30226	Modbus Zone105 Distance	Location of leak	Ft/Meters	0-65535
30227	Modbus Zone106 Status	Bit Level Status	None	0-65535
30228	Modbus Zone106 Distance	Location of leak	Ft/Meters	0-65535
30229	Modbus Zone107 Status	Bit Level Status	None	0-65535
30230	Modbus Zone107 Distance	Location of leak	Ft/Meters	0-65535
30231	Modbus Zone108 Status	Bit Level Status	None	0-65535
30232	Modbus Zone108Distance	Location of leak	Ft/Meters	0-65535
30233	Modbus Zone109 Status	Bit Level Status	None	0-65535

Table 5.5 Input Registers (continued)

Register	Name	Description	Units	Range
30234	Modbus Zone109 Distance	Location of leak	Ft/Meters	0-65535
30235	Modbus Zone110 Status	Bit Level Status	None	0-65535
30236	Modbus Zone110 Distance	Location of leak	Ft/Meters	0-65535
30237	Modbus Zone111 Status	Bit Level Status	None	0-65535
30238	Modbus Zone111 Distance	Location of leak	Ft/Meters	0-65535
30239	Modbus Zone112 Status	Bit Level Status	None	0-65535
30240	Modbus Zone112 Distance	Location of leak	Ft/Meters	0-65535
30241	Modbus Zone Enabled Flags (00=Modbus Zone113... 15=Modbus Zone 128)	Bit Level Status Modbus Zone 113 through Modbus Zone 128	None	0-65535
30242	Modbus Zone113 Status	Bit Level Status	None	0-65535
30243	Modbus Zone113 Distance	Location of leak	Ft/Meters	0-65535
30244	Modbus Zone114 Status	Bit Level Status	None	0-65535
30245	Modbus Zone114 Distance	Location of leak	Ft/Meters	0-65535
30246	Modbus Zone115 Status	Bit Level Status	None	0-65535
30247	Modbus Zone115 Distance	Location of leak	Ft/Meters	0-65535
30248	Modbus Zone116 Status	Bit Level Status	None	0-65535
30249	Modbus Zone116 Distance	Location of leak	Ft/Meters	0-65535
30250	Modbus Zone117 Status	Bit Level Status	None	0-65535
30251	Modbus Zone117 Distance	Location of leak	Ft/Meters	0-65535
30252	Modbus Zone118 Status	Bit Level Status	None	0-65535
30253	Modbus Zone118 Distance	Location of leak	Ft/Meters	0-65535
30254	Modbus Zone119 Status	Bit Level Status	None	0-65535
30255	Modbus Zone119 Distance	Location of leak	Ft/Meters	0-65535
30256	Modbus Zone120 Status	Bit Level Status	None	0-65535
30257	Modbus Zone120 Distance	Location of leak	Ft/Meters	0-65535
30258	Modbus Zone121 Status	Bit Level Status	None	0-65535
30259	Modbus Zone121 Distance	Location of leak	Ft/Meters	0-65535
30260	Modbus Zone122 Status	Bit Level Status	None	0-65535
30261	Modbus Zone122 Distance	Location of leak	Ft/Meters	0-65535
30262	Modbus Zone123 Status	Bit Level Status	None	0-65535
30263	Modbus Zone123 Distance	Location of leak	Ft/Meters	0-65535
30264	Modbus Zone124 Status	Bit Level Status	None	0-65535
30265	Modbus Zone124 Distance	Location of leak	Ft/Meters	0-65535
30266	Modbus Zone125 Status	Bit Level Status	None	0-65535
30267	Modbus Zone125 Distance	Location of leak	Ft/Meters	0-65535
30268	Modbus Zone126 Status	Bit Level Status	None	0-65535

Table 5.5 Input Registers (continued)

Register	Name	Description	Units	Range
30269	Modbus Zone126 Distance	Location of leak	Ft/Meters	0-65535
30270	Modbus Zone127 Status	Bit Level Status	None	0-65535
30271	Modbus Zone127 Distance	Location of leak	Ft/Meters	0-65535
30272	Modbus Zone128 Status	Bit Level Status	None	0-65535
30273	Modbus Zone128 Distance	Location of leak	Ft/Meters	0-65535

Table 5.5 [Input Registers \(continued\)](#)

Status Flags

Register 30010		Register 30011	
Bit	Description	Bit	Description
00	1 = Zone1	00	1 = Zone17
01	1 = Zone2	01	1 = Zone18
02	1 = Zone3	02	1 = Zone19
03	1 = Zone4	03	1 = Zone20
04	1 = Zone5	04	1 = Zone21
05	1 = Zone6	05	1 = Zone22
06	1 = Zone7	06	1 = Zone23
07	1 = Zone8	07	1 = Zone24
08	1 = Zone9	08	1 = Zone25
09	1 = Zone10	09	1 = Zone26
10	1 = Zone11	10	1 = Zone27
11	1 = Zone12	11	1 = Zone28
12	1 = Zone13	12	1 = Zone29
13	1 = Zone14	13	1 = Zone30
14	1 = Zone15	14	1 = Zone31
15	1 = Zone16	15	1 = Zone32

Table 5.6 [Status Flags \(Registers 30010 and 30011\)](#)

Bit	Description
00	1= Leak Detected
01	1 = Cable Break
02	1 = Contamination
07	1 = Communication Loss

Table 5.7 [Status Flags \(Register 30013 - 30273\)](#)

5.4.3 Function 06: Preset Single Register

To set the LD5200 parameter value, the master must send a Preset Single Register request packet. The Preset Single Register request packet specifies a register and the data to write to that register. The register is numbered from zero (40001 = zero, 40002 = one, etc).

Preset Register Request Packet	Preset Register Response Packet
Slave Address (1 byte)	Slave Address (1 byte)
06 (Function code) (1 byte)	06 (Function code) (1 byte)
Register (2 bytes)	Register (2 byte)
Data (2 bytes)	Data (2 bytes)
Crc Checksum (2 bytes)	Crc Checksum (2 bytes)

Table 5.8 Preset Single Register Packet Structure

5.4.4 Function 16: Preset Multiple Registers

To set multiple LD5200 parameter values, the master must send a Preset Multiple Registers request packet. The Preset Multiple Register request packet specifies a starting register, the number of registers, a byte count and the data to write to the registers. The register is numbered from zero (40001 = zero, 40002 = one, etc).

Preset Registers Request Packet	Preset Registers Response Packet
Slave Address (1 byte)	Slave Address (1 byte)
16 (Function code) (1 byte)	16 (Function code) (1 byte)
Start Register (2 bytes)	Start Register (2 bytes)
# of registers to write (2 bytes)	# of registers (2 bytes)
Byte Count (1 byte)	Crc Checksum (2 bytes)
Data (2 bytes)	
...	
...	
Crc Checksum (2 bytes)	

Table 5.9 Preset Multiple Registers Packet Structure

5.5 RTU Framing

The example below shows a typical Query/Response from the LD5200 module.

Slave Address	Function Code	Starting Register "Msb"	Starting Register "Lsb"	Numbers of Registers "Lsb"	Number of Registers "Lsb"	CRC 16 "Lsb"	CRC "Msb"
02	04	00	00	00	03	B5	A3

Table 5.10 Query Sample

Slave Address	Function Code	Count Bytes of Data	Register Data Msb Lsb	Register Data Msb Lsb	Register Data Msb Lsb	CRC 16 "Lsb"	CRC 16 "Msb"
02	04	06	00 00	00 00	00 01	B5	A3

Table 5.11 Response Sample

Slave address 2 responds to Function Code 4 with 6 bytes of hexadecimal data and ends with CRC16 checksum

Register Values:

40001 = 0000 (hex)

40002 = 0000 (hex)

40003 = 0001 (hex)



UPDATE FIRMWARE

A.1 Update the LD5200 Firmware

Firmware updates are available online at rletech.com. Locate the most recent firmware (.bin file) for the LD5200. *Using the same filename*, save the file to a local drive and note the file's location.

Do not change the name of the firmware file when you save it. The LD5200 will not recognize a renamed file.

1 Access the LD5200's web interface. Click on the Configuration tab at the top of the page, and then the System/Flash Management link on the left hand side of the page.

The screenshot shows the SeaHawk web interface for RLE Technologies LD5200. The top navigation bar includes 'Home', 'Identity', 'Configuration', 'Historical Data', and 'Refresh'. The main content area is titled 'System Management' and contains several buttons: 'Exit To Bootloader', 'LCD Capture', and 'LCD Program'. Below these buttons are links for 'Download LCD Capture File (.bin)' and 'Download Configuration File (.cfg)'. There is a section for 'Configuration and Program updates from your computer' with a 'Browse...' button and an 'Upload' button. A note at the bottom states: 'Note: This version also supports tftp for configuration and program updates.' The footer of the page shows 'LD5200 - Main' and '©2011 RLE Technologies'.

Figure A.1 System/Flash Management Page

2 Click the Download Configuration File (.cfg) link. Download your LD5200's .cfg file to a local drive. This serves as a backup of your module's configuration information.

3 Click the Browse button.

4 Locate and select the firmware file (.bin) that you saved from the RLE website.

The path and name of the firmware file (.bin) displays in the field to the left of the Browse button.

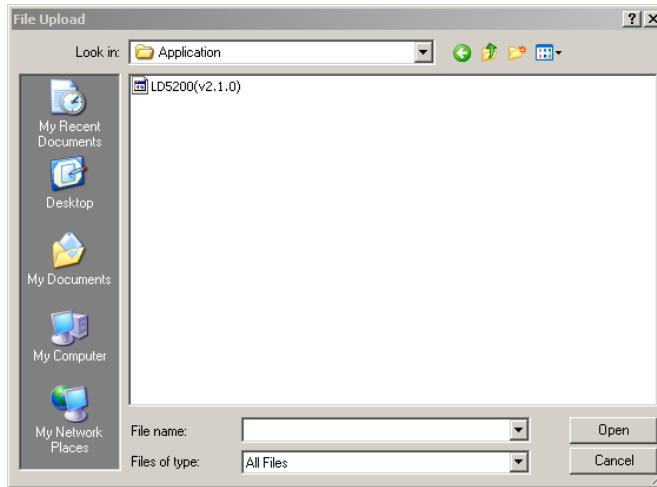

Configuration and Program updates from your computer:

Note: This version also supports tftp for configuration and program updates.

Figure A.2 Choose the Firmware File

5 Click the Upload button.

The firmware loads while the web interface displays a message confirming that it is loading the new file. During this process, the LD5200 module displays a “System is Rebooting.” message and then reboots.

File has been uploaded and bin file verified

File will now be copied to flash and the ld5200 will reboot in about 60 seconds

If your browser does not automatically redirect you, please click [here](#) after waiting.

Figure A.3 Firmware Load Message

6 Once the LD5200 has rebooted, the web interface returns to its Home page. The firmware update is complete, and the LD5200 has resumed its normal operation.

B

EIA-232 INTERFACE

The EIA-232 Interface is used primarily for advanced diagnostic and configuration.



WARNING

The Bootloader section is designed for experienced technicians or users responsible for maintaining the system. **EXIT IMMEDIATELY** if you are not trained in the use of the Bootloader commands.

Contact the manufacturer for more information regarding the commands in this section.

B.1 Set the IP Address through the EIA-232 Port

- 1 Connect the EIA-232 port (P1) on the LD5200 to a terminal or PC running terminal emulation software (HyperTerminal) with a 9-pin male-female straight through serial cable.
2. Set the appropriate communication port to **9600 baud, NO parity, 8 data bits, 1 stop bit, (9600/N/8/1)**, and **no software or hardware flow command**.
- 3 Once the terminal emulation software starts, type ? and press **Enter** on the keyboard and the Main Menu should appear. If the Main Menu does not appear, check the communication settings and make sure the unit is powered on.
- 4 From the Main Menu type **netcfg** to select the Network Configuration Menu.
 - ◆ Enter the new IP address for the LD5200 by typing `ip xxx.xxx.xxx.xxx`, where `xxx.xxx.xxx.xxx` is the new IP address of the unit. Separate each field with a decimal point. For example, type `ip 10.0.0.50 <Enter>`.
 - ◆ The LD5200 erases a memory block and copies data to flash memory before rebooting.
 - ◆ The LD5200 IP address is now set and the LD5200 can be accessed through a Web browser using the new IP address.

- Repeat step 4 to change the Subnet Mask and Default Route (gateway), if needed, using the commands `nm xxx.xxx.xxx.xxx` to change the Subnet Mask and `dg xxx.xxx.xxx.xxx` to change the default gateway.

B.2 Boot Up

Make sure the EIA-232 port is connected to a PC or terminal with a straight through cable (not provided). Run terminal emulation software (i.e., HyperTerminal) and make sure the settings match the LD5200 EIA-232 port configuration; refer to “P1: EIA-232 Connector” on page 19 for port configuration details. When the LD5200 is powered up, diagnostics are performed. The boot ROM and flash program code are verified.

B.3 Main Menu

Once the system is entirely booted, press the **Enter** key on your PC or terminal to display the Main Menu.

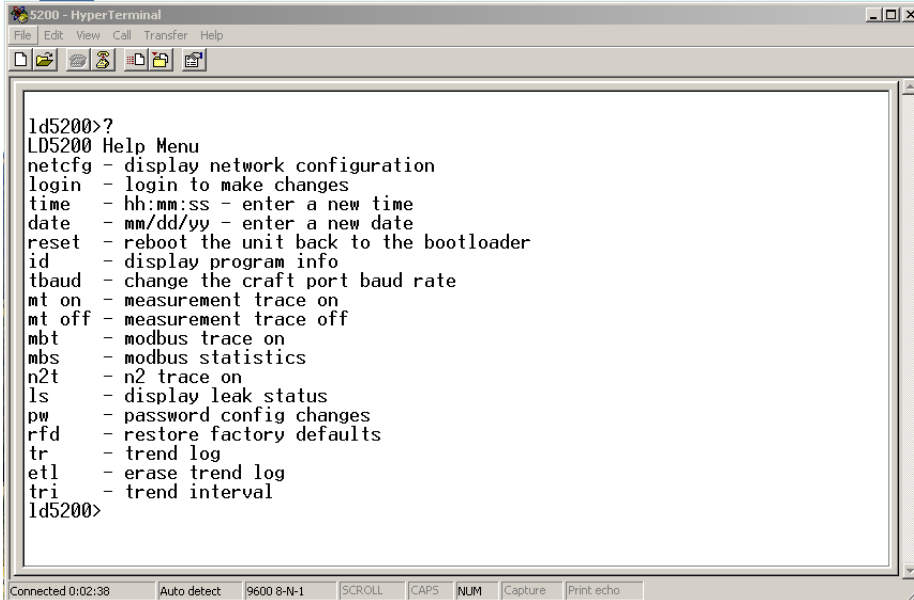

```

ld5200>?
LD5200 Help Menu
netcfg - display network configuration
login - login to make changes
time - hh:mm:ss - enter a new time
date - mm/dd/yy - enter a new date
reset - reboot the unit back to the bootloader
id - display program info
tbaud - change the craft port baud rate
mt on - measurement trace on
mt off - measurement trace off
mbt - modbus trace on
mbs - modbus statistics
n2t - n2 trace on
ls - display leak status
pw - password config changes
rfd - restore factory defaults
tr - trend log
etl - erase trend log
tri - trend interval
ld5200>

```

Figure B.1 EIA-232 Main Menu Screen

B.4 Other Main Menu Functions

The remainder of the functions available from the Main Menu of the EIA-232 interface are described in Table B.1.

Option	Description
netcfg	Display the network configuration.
login	Log in to the system to make changes
time	Adjust the LD5200's time. Enter the time in hh:mm:ss format.
date	Adjust the LD5200's date. Enter the date in mm/dd/yy format.
reset	Reboot the unit back to the bootloader.
id	Display program information for the unit.
tbaud	Change the craft port's baud rate.
mt on	Measurement Trace On - displays advanced manufacturer diagnostics of the microprocessor.
mt off	Measurement Trace Off - turns off the display of advanced manufacturer diagnostics of the microprocessor.
mbt	Turn on the Modbus trace.
mbs	View Modbus statistics.
n2t	Turn on the N2 trace.
ls	Display the current cable readings, including both cable length and any present current leakage.
pw	Change the configuration password.
rfd	Restore the LD5200 to the factory default configuration.
tr	View the trend log.
etl	Erase the trend log.
tri	View or adjust the trend interval

Table B.1 Other Main Menu Functions

C

PREVENTIVE MAINTENANCE

Follow these steps monthly to test the system and ensure that the control panel is functioning properly:

- 1 Place water on the cable.
- 2 Verify the Leak Detected alarm on the control panel.
- 3 Compare the distance reading on the LD5200 LCD to the reference map to verify that the LD5200 displays the correct leak location.
- 4 Dry the cable and verify that the LD5200 returns to normal.
- 5 Remove the end-of-line terminator.
- 6 Verify the Cable Break alarm on the control panel.
- 7 Reinstall the end-of-line terminator.
- 8 Verify that the LD5200 returns to normal.

Monitor the cable current monthly to verify that the cable is not being contaminated. The LD5200 will alarm on cable contamination if the contamination exceeds the cable contamination threshold.

- 1 From the LD5200's LCD, press the **Status** key.
- 2 Ensure the cable current is less than 15 μ A. If the cable current is greater than 15 μ A, one of the cables is contaminated. Refer to Appendix D, "Troubleshooting" on page 111 to troubleshoot the cables and determine which cable is contaminated. The contaminated cable should be removed, cleaned, retested and reinstalled.

APPENDIX

D

TROUBLESHOOTING

D.1. Troubleshooting Problems with the LD5200

Problem	Action
Control Panel will not Power Up	<ol style="list-style-type: none"> 1 Check with a DVM (digital volt meter) for AC input power on the AC power input terminal. If no AC power is present at the terminal block, check the input circuit breaker that powers the LD5200. If voltage is present, go to step 2. 2 Check for 24 VDC at input power terminal block, TB7 pins 1 and 2. If no voltage is present across these pins, the power supply has failed. Contact RLE Technologies for a replacement. If voltage is present, contact RLE Technologies for further troubleshooting.
Unit Powers Up without Proper Display on LCD	<ol style="list-style-type: none"> 1 Open the front door and verify that the connectors that link J2 on the LCD display board with J4 on the main board are fully connected and the wires are undamaged. 2 Update the front panel LCD's firmware. Refer to "System/Flash Management" on page 83 for more detailed instructions.

Table D.1 Troubleshoot Problems with the LD5200

Problem	Action
Cable Break Alarm	<ol style="list-style-type: none"> <li data-bbox="626 247 1427 373">1 Verify that the leader cable is plugged into terminal block TB2, and the wires are ordered in the terminal block from left to right, White - Black - Green - Red. If the leader cable is installed correctly, proceed to step 2. <li data-bbox="626 394 1427 489">2 Verify that the end-of-line terminator (EOL) is installed on the end of the orange sensing cable run. If the EOL is installed correctly, proceed to step 3. <li data-bbox="626 510 1427 1014">3 If the cable break alarm is still present, there may be a damaged or faulty section of sensing cable. Remove the EOL from the end of the cable run and install it onto the end of the leader cable coming from the control panel. If the condition clears, one of the sections of sensing cable is damaged or faulty. To determine which section of sensing cable has a problem, reconnect the leader cable to the sensing cable run. Move to the connection between the first two sections of sensing cable, separate the connection, and install the EOL on the end of the first section of sensing cable. If the alarm sounds, that first section of cable is damaged or faulty. If the alarm clears, the first section is fine. Move the EOL to the end of the next section of sensing cable, and proceed until you isolate the faulty section. If none of the sections of the cable appear to be faulty, and if the condition does not clear, go to step 4. <li data-bbox="626 1035 1427 1264">4 Power down (shut off) the LD5200. Remove terminal block TB2 from the main board. Remove the leader cable from the terminal block. Install a jumper wire between pins 1 and 2 and another jumper wire between pins 3 and 4. Reinstall the terminal block back into TB2. If the cable break condition clears, there is a problem with the leader cable. If the condition does not clear, contact RLE Technologies for further support.
Control Panel not Calculating Proper Length of Cable	<ol style="list-style-type: none"> <li data-bbox="626 1276 1427 1371">1 The LD5200 is pre-calibrated from the factory. The overall reported cable footage should be within 5% of actual installed length. <li data-bbox="626 1392 1427 1549">2 If your reading is not within 5%, verify that the LD5200 is operating with the correct cable resistance per foot for the sensing cable connected to the system. Consult “Leak Settings” on page 37 to adjust the resistance with the LCD, or “Leak” on page 50 to adjust the resistance via the web interface. <li data-bbox="626 1570 1427 1665">3 If the resistance is correct, verify the proper leader cable wiring order into TB2. Wiring color code should be as follows from left to right: White - Black - Green - Red. <li data-bbox="626 1686 1427 1787">4 If the leader cable wiring is correct, calibrate your cable. To do this, refer to “Calibrate Cable Resistance” on page 25. If calibration does not fix the problem, contact RLE Technologies.

Table D.1 Troubleshoot Problems with the LD5200 (continued)

Problem	Action
Control Panel not Calculating Proper Leak Distance	<ol style="list-style-type: none"> <li data-bbox="675 243 1468 499">1 Check the distance on the cable run to verify that the control panel is monitoring. Verify there is no water along the cable run. Check to see if multiple leaks are present on the cable. The first leak should be read and latched by the system; however, if the system is updated or simultaneous leaks occur (2 or more) within 30 seconds of the initial leak, the system may display the average distance (distance of the first leak + distance of the second leak / 2). If no water is present, go to step 2. <li data-bbox="675 520 1468 978">2 Power down (shut off) the control panel and remove the end-of-line terminator (EOL) from the end of the SC cable. Locate the first section of SC cable from the LD5200 control panel. Where it joins to the second section of cable, disconnect and install the End-of-Line terminator at the end of the first section of SC cable. Turn power back on at control panel. Once the control panel runs for five to ten minutes, use a damp cloth, rag or paper towel and place it on the end of the orange SC cable. If the leak is calculated correctly, remove the end-of-line terminator; reconnect the SC cable and move down to the next section of cable. Repeat this process until a faulty reading is obtained. If the reading is off at the first section of cable, there may be miscalculations from the LD5200 unit, please contact RLE Technologies for support.
Cable Contamination Alarm: Unit's Alarm History Displays: "Cable Contaminated @ XXXX Ft"	<ol style="list-style-type: none"> <li data-bbox="675 978 1468 1073">1 To clear a contamination alarm, the cable must be removed and cleaned. Usually the cable can be cleaned by pulling it through a clean damp rag. <li data-bbox="675 1094 1468 1293">2 If the cable is contaminated by oil, Glycol or chemicals, the cable can be washed. Use a mild detergent solution of 1 capful to 2 gallons lukewarm water (<105°F). Agitate the cable in a suitable container, rinse with clear lukewarm water and wipe dry with a clean towel. The cable may also be cleaned by wiping it down with Isopropyl Alcohol. <li data-bbox="675 1314 1468 1379">3 Retest the cable by connecting it to the LD5200 before reinstalling it under the floor.

Table D.1 Troubleshoot Problems with the LD5200 (continued)

D.2. Troubleshooting Sensing Cable

Note Contamination and/or physical damage to the cable is not covered under warranty. For all other troubleshooting concerns and questions regarding this product, contact RLE Technologies at 800-518-15198 or access our website at rletech.com.

Question	Answer
My water leak detection cable touches metal surfaces. Is this a problem or a potential problem?	In general, no. The two water sensing wires are covered by a nonconductive polymer weave. This weave isolates the cable from metal surfaces. However, as with all electrical wires and cable, avoid sharp objects that can slice or pierce through the insulation and nonconductive polymer weave.
The sensing cable is routed so that it has to cross over itself. Can this cause false alarms?	Crossing sensing cables will not cause false alarms, but it can cause a false distance reading if a leak occurs at the crossover point. If the cables must cross, use a 10 foot section of non-sensing cable to jump over the section of sensing cable.
If I suspect a bad section of sensing cable, how can I verify that it is ok without sending it back to RLE for warranty evaluation?	It can be very difficult to remove sensing cable, so verify the cable is working before you attempt to remove it and return it to the manufacturer. Use either a cable tester (RLE part # LDCE) or refer to the Cable Break Alarm assessment in Table D.1, "Troubleshoot Problems with the LD5200" to determine which section of cable may be faulty.
How do I secure sensing cable to the floor?	RLE recommends the use of J-clips. J-clips are nylon cable clips with a self-adhesive backing. J-clips hold sensing cable securely in place without pinching or binding the cable, which can cause false alarms. J-Clips should be placed 5 to 6 feet apart throughout an installation, and 3 feet apart when cable is routed in front of CRAC units. Because the J-clip's adhesive backing does not work well on porous concrete floors, apply a drop of silicone or another nonconductive adhesive to help secure the J-Clip to the floor.

Table D.2 Troubleshoot Sensing Cable

Question	Answer
How do I clean the cable?	<p>Use a mild detergent solution - 1 cap full of Dawn liquid dishwashing detergent to 2 gallons of lukewarm water (<105 degrees F) - to clean sensing cables. Put the cable into a bucket filled with the solution, agitate the cable, rinse, and gently wipe dry. Test the cable prior to reinstallation to be sure it has been thoroughly cleaned of contaminants.</p> <p>If only a small section of the cable needs to be cleaned, wipe the contaminated area of the cable with isopropyl alcohol.</p>
My system shows an alarm condition, but a leak is not found at location shown on display. The system will not clear. It is in alarm all the time!	<p>The most common causes for this condition includes:</p> <ol style="list-style-type: none"> <li data-bbox="675 594 1468 884">1 Water is touching the cable in two places at the same time. The distance reading is an average of the two values. For example, if leaks are detected at 200 feet and at 100 feet, the system would register a leak at 150 feet ($(200 + 100)/2 = 150$). This is a common problem when, after an alarm sounds, the operator resets the system without recording the first value displayed. It is very rare that water will touch two places on the same cable at the exact same time. This situation is true for all systems which measure distance. Check the Alarm History log for the first incidence of the leak. <li data-bbox="675 909 1468 1499">2 The cable has been exposed to high humidity, or the dew point has been reached. This is especially common when two or more air conditioners share the same under-floor space. Problems of this nature can be resolved as follows: <ol style="list-style-type: none"> <li data-bbox="704 1052 1468 1167">a Fix the air conditioners. This is sometimes easier said than done as most people believe if the unit is on and cooling, it is working properly. Extensive investigation may have to be done just to prove the air conditioner is faulty. <li data-bbox="704 1192 1468 1308">b Turn the sensitivity adjustment on the controller to its least sensitive setting - refer to Chapter 3, "LCD Touch Screen Interface" on page 29. This should keep the system from alarming, but will not resolve the air conditioner problem. <li data-bbox="704 1333 1468 1386">c Move the cable at least 10' away from the front of the air conditioner <li data-bbox="704 1411 1468 1499">d Cover the sensing cable in front of the air conditioner with spiral wrap (plastic covering which allows water in but keeps dew point from condensing water on the cable). <li data-bbox="675 1524 1468 1640">3 A cable has been contaminated either chemically (floor sealing chemicals dissolve and damage cable), or physically (small metallic chips from filings or solder around pipes or wires from electrical installation). This requires replacement of the cable. <li data-bbox="675 1665 1468 1753">4 The cable has become damaged - most often from a floor tile being dropped on it. Damaged cable must be repaired or replaced.

Table D.2 Troubleshoot Sensing Cable (continued)

APPENDIX

E

4-20mA OUTPUT TESTING

The LD5200's 4-20mA output is loop powered and tested by the manufacturer. The manufacturer guarantees its performance upon delivery. Should the 4-20mA output need to be tested in the field, follow these steps. The following procedure is performed with the cable connected, unless otherwise indicated.

- 1 Turn off all power to the LD5200
- 2 Remove the two position plug from TB1.
- 3 Remove any wires from the terminal and install a 200Ohm resistor to TB1-2 (-). Then apply +24V (TB7-2) to TB1-1 (+) and ground (TB7-1) of the 24V supply to the other side of the resistor.
- 4 Reinstall the plug on TB1.
- 5 Reapply power to the LD5200.
- 6 With the system on and no alarms present, measure the DC voltage across the resistor. A value of 0.8VDC or 1.0VDC should register. This equates to 4mA or 5mA (depending on the LD5200's configuration), or normal operation.

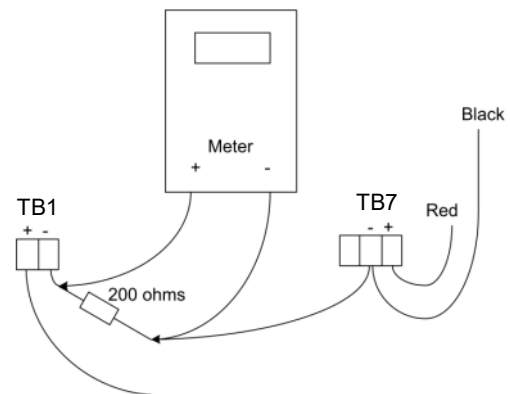

Figure E.1 4-20mA Testing

- 7 Remove the SeaHawk Leak Detection Cable (SC) and wait for the unit to activate its cable trouble alarm. Measure the DC voltage across the resistor. A value of approximately 3.8VDC or 4.0VDC should be measured. This equates to 19mA or 20mA (depending on the LD5200's configuration), or a fault alarm. Reconnect the SC cable.
- 8 Place water on the end of the SC cable. Measure the DC voltage across the resistor. The value will be proportional to the length of cable measured by the LD5200 and scaled according to the range setting. Dry the cable.
- 9 Place water on the start of the cable. Measure the DC voltage across the resistor. A measurement of approximately 0.8VDC or 0.9VDC, or 4mA or 5mA (both depending on the LD5200's configuration), should be measured. This corresponds to a leak at zero distance. Dry the cable.

- 10 Turn off power to the LD5200.
- 11 Remove the resistor and wires from the plug and reattach any wires as necessary.
- 12 Reapply power to the LD5200.

APPENDIX

F

TECHNICAL SPECIFICATIONS

Table F.1 Technical Specifications

Power	<i>Requires a dedicated circuit within close proximity, marked as the disconnecting device for the LD5200.</i> 100-240VAC @ 500mA max, 50/60 Hz power supply; dedicated circuit required	
Inputs		
	Sensing Cable	Compatible with all SeaHawk sensing cables (not included)
	Cable Input	Requires SeaHawk LC-KIT: 15ft (4.57m) leader cable and EOL (included)
	Maximum Sensing Cable Length	10,000ft (3048m) of sensing cable
	Minimum Sensing Cable Length	35ft (10.67m)
	Detection Accuracy	± 2ft (0.6m) +/- 0.5% of the cable length
	Detection Repeatability	± 2ft (0.6m) +/- 0.25% of the cable length
	Detection Response Time	5-990sec., software adjustable in 5sec. increments; ±2sec.
Outputs		
	Analog	4-20mA Loop Powered, 18-36VDC, RL = 500ohm max.
	Relay	1 DPDTLeak Relay, 1 DPDTCable Break Relay - each can be sent to two places; 1A @ 24VDC, 0.5A resistive @ 120VAC; configurable for supervised or non-supervised, latched or non-latched
	Maintenance Relay	1A @ 24VDC, 0.5A resistive @ 120VAC; configurable for supervised or non-supervised, latched or non-latched
Communications Ports		
	EIA-485 (Port 1, Port 2, Port 3)	9600, 19200, or 38400 baud (selectable); No parity, 8 data bits, 1 stop bit
	EIA-232	9600 baud; No parity, 8 data bits, 1 stop bit
	RJ-45	10/100BaseT Ethernet port (TCP/IP)

Table F.1 Technical Specifications (continued)

Protocols	
EIA-485	Modbus RTU, Master & Slave; BACnet MS/TP; N2, Slave
EIA-232	Terminal emulation, VT100 compatible
RJ-45	Ethernet, TCP/IP; Modbus/TCP/UDP, Master & Slave; SNMP V1, V2, V3, NTP, SMTP, DNS; BACnet/IP
Alarm Notification	
Audible Alarm	85dBA @ 2ft (0.6m); re-sound 0-999min.
Visible Alarm	Alarm indicated on LCD touch screen and through web interface
Logging Capabilities	
	Logs are downloadable to .txt file
Alarm History/Event Log	Last 1,024 events
Trend Log	Cable current level every day, for the last 365 days
Login Security	
LCD Touch Screen	No password required to view controller status and data. Administrator password limits access to configuration options.
Web Interface	Username and password can be configured.
Front Panel Interface	
Display	480 x 272 pixel color backlit LCD touch screen; 95.04mm x 53.85 mm
Operating Environment	
Temperature	32° to 122°F (0° to 50°C)
Humidity	5% to 95% RH, non-condensing
Altitude	15,000ft (4,572m) max.
Storage Environment	-4° to 185°F (-20° to 85°C)
Dimensions	12.5"W x 10"H x 3.25"D (318mmW x 254mmH x 83mmD)
Weight	8.2 lbs. (3.7kg)
Mounting	Type 1 wall mount enclosure
Certifications	CE; ETL listed: conforms to UL 61010-1, EN 61010-1; certified to CSA C22.2 NO. 61010-1; RoHS compliant